

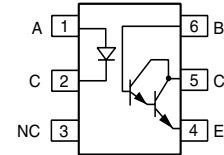

Optocoupler, Photodarlington Output, High Gain, With Base Connection

Features

- Isolation test voltage, 5300 V_{RMS}
- Coupling capacitance, 0.5 pF
- Fast rise time, 10 μs
- Fast fall time, 35 μs

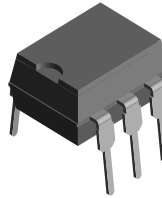

1179005

Agency Approvals

- UL File E52744 System Code H or J
- DIN EN 60747-5-2(VDE0884)
DIN EN 60747-5-5 pending
Available with Option 1
- CSA 93751
- BSI IEC60950 IEC60965

Description

The MCA230/ MCA231/ MCA255 are industry standard optocouplers, consisting of a gallium arsenide infrared LED and a silicon photodarlington. These optocouplers are constructed with a high voltage insulation packaging process which offers 7.5 kV withstand test capability.

Order Information

Part	Remarks
MCA230	CTR > 100 %, DIP-6
MCA231	CTR > 200 %, DIP-6
MCA255	CTR > 100 %, DIP-6
MCA231-Xxx9	CTR > 200 %, SMD-6 (option 9)

For additional option information and package dimensions see Option Section.

Absolute Maximum Ratings

T_{amb} = 25 °C, unless otherwise specified

Stresses in excess of the absolute Maximum Ratings can cause permanent damage to the device. Functional operation of the device is not implied at these or any other conditions in excess of those given in the operational sections of this document. Exposure to absolute Maximum Rating for extended periods of the time can adversely affect reliability.

Input

Parameter	Test condition	Symbol	Value	Unit
Reverse voltage		V _R	6.0	V
Forward continuous current		I _F	60	mA
Power dissipation		P _{diss}	135	mW
Derate linearly from 25 °C			1.8	mW/°C

Output

Parameter	Test condition	Part	Symbol	Value	Unit
Collector-emitter breakdown voltage		MCA230	BV _{CEO}	30	V
		MCA231	BV _{CEO}	30	V
		MCA255	BV _{CEO}	55	V
Emitter-collector breakdown voltage			BV _{ECO}	7.0	V

Parameter	Test condition	Part	Symbol	Value	Unit
Collector-base breakdown voltage		MCA230	BV_{CBO}	30	V
		MCA231	BV_{CBO}	30	V
		MCA255	BV_{CBO}	55	V
Power dissipation			P_{diss}	210	mW
Derate linearly from 25 °C				2.8	mW/°C

Coupler

Parameter	Test condition	Symbol	Value	Unit
Total package dissipation (LED plus detector)		P_{tot}	260	mW
Derate linearly from 25°C			3.5	mW/°C
Storage temperature		T_{stg}	- 55 to + 150	°C
Operating temperature		T_{amb}	- 55 to + 150	°C
Lead soldering time at 260°C			10	sec.
Isolation test voltage		V_{ISO}	5300	V_{RMS}
Isolation resistance	$V_{IO} = 500\text{ V}, T_{amb} = 25\text{ °C}$	R_{IO}	10^{12}	Ω
	$V_{IO} = 500\text{ V}, T_{amb} = 100\text{ °C}$	R_{IO}	10^{11}	Ω

Electrical Characteristics

$T_{amb} = 25\text{ °C}$, unless otherwise specified

Minimum and maximum values are testing requirements. Typical values are characteristics of the device and are the result of engineering evaluation. Typical values are for information only and are not part of the testing requirements.

Input

Parameter	Test condition	Symbol	Min	Typ.	Max	Unit
Forward voltage	$I_F = 50\text{ mA}$	V_F		1.1	1.5	V
Reverse current	$V_R = 3.0\text{ V}$	I_R			10	μA
Junction capacitance	$V_R = 3.0\text{ V}$	C_j		50		pF

Output

Parameter	Test condition	Part	Symbol	Min	Typ.	Max	Unit
Collector-emitter breakdown voltage	$I_C = 100\text{ }\mu\text{A}, I_F = 0\text{ mA}$	MCA230	BV_{CEO}	30			V
		MCA231	BV_{CEO}	30			V
		MCA255	BV_{CEO}	30			V
Emitter-collector breakdown voltage	$I_E = 10\text{ }\mu\text{A}, I_F = 0\text{ mA}$		BV_{ECO}	7.0			V
Collector-base breakdown voltage	$I_C = 10\text{ }\mu\text{A}, I_F = 0\text{ mA}$	MCA230	BV_{CBO}	30			V
		MCA231	BV_{CBO}	30			V
		MCA255	BV_{CBO}	55			V
Collector-emitter leakage current			I_{CEO}			100	nA

Coupler

Parameter	Test condition	Symbol	Min	Typ.	Max	Unit
Collector-emitter saturation voltage	$I_{CE} = 2.0 \text{ mA}, I_F = 16 \text{ mA}$	V_{CEsat}			0.8	V
	$I_C = I_F = 50 \text{ mA}$	V_{CEsat}			1.0	V
	$I_C = 2.0 \text{ mA}, I_F = 1.0 \text{ mA}$	V_{CEsat}			1.0	V
	$I_C = 10 \text{ mA}, I_F = 5.0 \text{ mA}$	V_{CEsat}			1.0	V
	$I_C = 50 \text{ mA}, I_F = 10 \text{ mA}$	V_{CEsat}			1.2	V
Capacitance (input-output)		C_{IO}		0.5		pF

Current Transfer Ratio

Parameter	Test condition	Symbol	Min	Typ.	Max	Unit
DC Current Transfer Ratio	$V_{CE} = 5.0 \text{ V}, I_F = 10 \text{ mA}$	CTR_{DC}	100			%
	$V_{CE} = 5.0 \text{ V}, I_F = 1.0 \text{ mA}$	CTR_{DC}	200			%

Switching Characteristics

Parameter	Test condition	Symbol	Min	Typ.	Max	Unit
Switching times	$R_L = 100 \Omega, V_{CE} = 10 \text{ V}$	t_{on}		10		μs
		t_{off}		30		μs

Typical Characteristics ($T_{amb} = 25 \text{ }^\circ\text{C}$ unless otherwise specified)

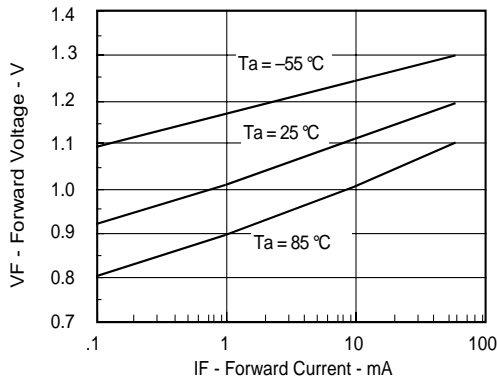

imca230_01

Figure 1. Forward Voltage vs. Forward Current

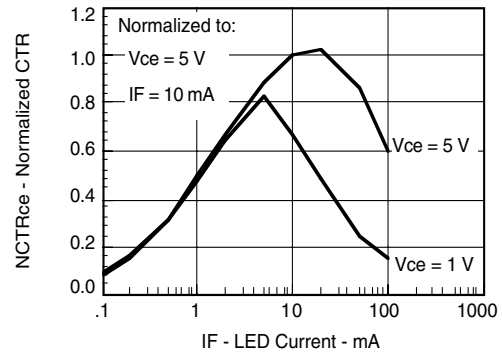

imca230_02

Figure 2. Normalized Non-saturated and Saturated CTR vs. LED Current

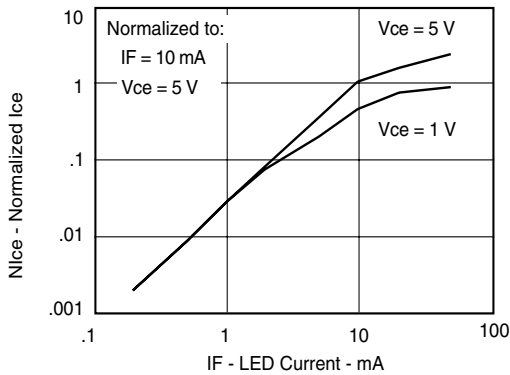

imca230_03

Figure 3. Normalized Non-saturated and Saturated Collector-emitter Current vs. LED Current

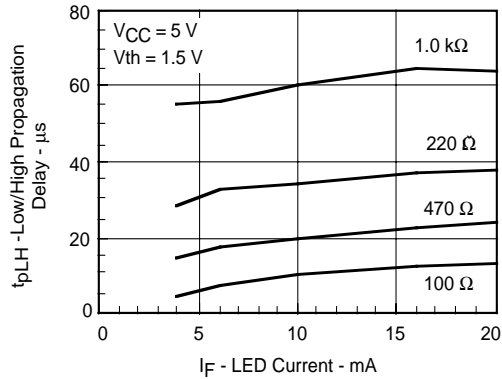

imca230_06

Figure 6. Low to High Propagation Delay vs. Collector Load Resistance and LED Current

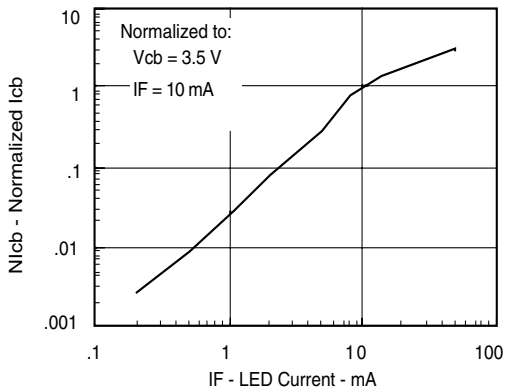

imca230_04

Figure 4. Normalized Collector-Base Photocurrent vs. LED Current

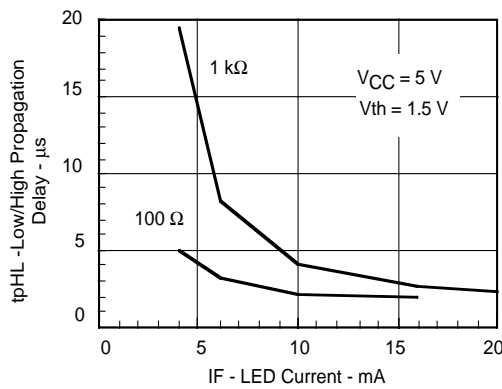

imca230_07

Figure 7. High to low Propagation Delay vs. Collector Load Resistance and LED Current

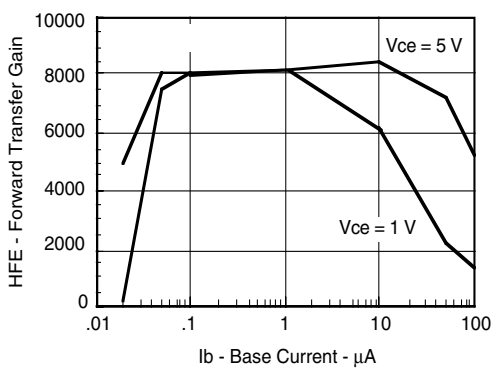

imca230_05

Figure 5. Non-saturated and Saturated HFE vs. Base Current

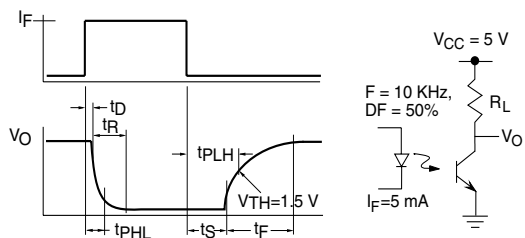

imca230_08

Figure 8. Switching timing waveform and schematic



Package Dimensions in Inches (mm)

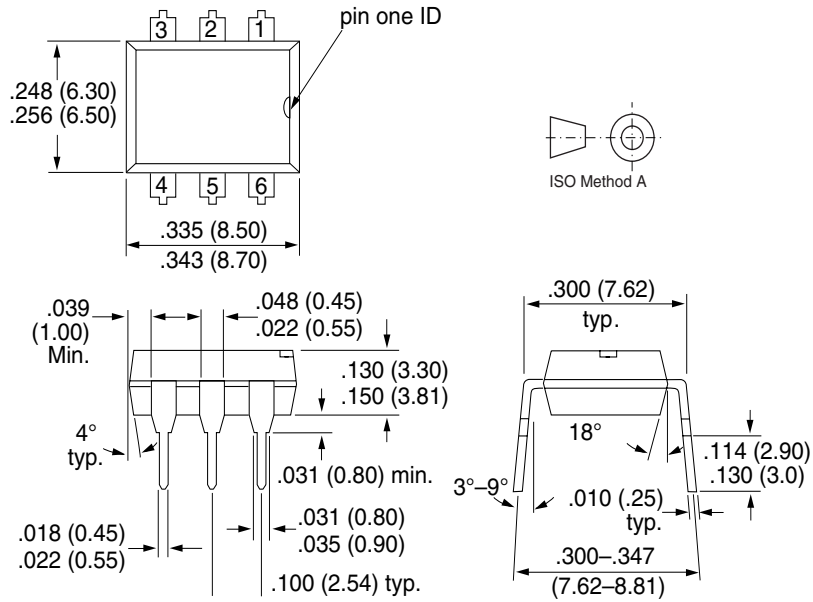

i178004

Option 9

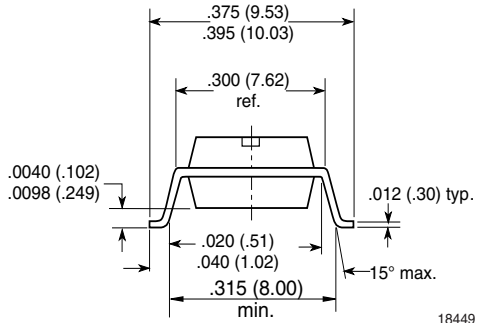

18449

Ozone Depleting Substances Policy Statement

It is the policy of **Vishay Semiconductor GmbH** to

1. Meet all present and future national and international statutory requirements.
2. Regularly and continuously improve the performance of our products, processes, distribution and operating systems with respect to their impact on the health and safety of our employees and the public, as well as their impact on the environment.

It is particular concern to control or eliminate releases of those substances into the atmosphere which are known as ozone depleting substances (ODSs).

The Montreal Protocol (1987) and its London Amendments (1990) intend to severely restrict the use of ODSs and forbid their use within the next ten years. Various national and international initiatives are pressing for an earlier ban on these substances.

Vishay Semiconductor GmbH has been able to use its policy of continuous improvements to eliminate the use of ODSs listed in the following documents.

1. Annex A, B and list of transitional substances of the Montreal Protocol and the London Amendments respectively
2. Class I and II ozone depleting substances in the Clean Air Act Amendments of 1990 by the Environmental Protection Agency (EPA) in the USA
3. Council Decision 88/540/EEC and 91/690/EEC Annex A, B and C (transitional substances) respectively.

Vishay Semiconductor GmbH can certify that our semiconductors are not manufactured with ozone depleting substances and do not contain such substances.

**We reserve the right to make changes to improve technical design
and may do so without further notice.**

Parameters can vary in different applications. All operating parameters must be validated for each customer application by the customer. Should the buyer use Vishay Semiconductors products for any unintended or unauthorized application, the buyer shall indemnify Vishay Semiconductors against all claims, costs, damages, and expenses, arising out of, directly or indirectly, any claim of personal damage, injury or death associated with such unintended or unauthorized use.

Vishay Semiconductor GmbH, P.O.B. 3535, D-74025 Heilbronn, Germany
Telephone: 49 (0)7131 67 2831, Fax number: 49 (0)7131 67 2423