

TIL113, TIL119A OPTOCOUPLED

SOOS042A D1499, AUGUST 1981 - REVISED JUNE 1989

- Gallium Arsenide Diode Infrared Source Optically Coupled to a Silicon N-P-N Darlington-Connected Phototransistor
- High Direct-Current Transfer Ratio . . . 300% Minimum at 10 mA
- High-Voltage Electrical Isolation . . . 1500-Volt Rating
- Plastic Dual-In-Line Package
- Base Lead Provided on TIL113 for Conventional Transistor Biasing
- No Base Lead Connection on TIL119A for High-EMI Environments
- Typical Applications Include Remote Terminal Isolation, SCR and Triac Triggers, Mechanical Relays, and Pulse Transformers

mechanical data

The package consists of a gallium arsenide infrared-emitting diode and an n-p-n silicon darlington-connected phototransistor mounted on a 6-lead frame encapsulated within an electrically nonconductive plastic compound. The case will withstand soldering temperature with no deformation and device performance characteristics remain stable when operated in high-humidity conditions. Unit weight is approximately 0.52 grams.

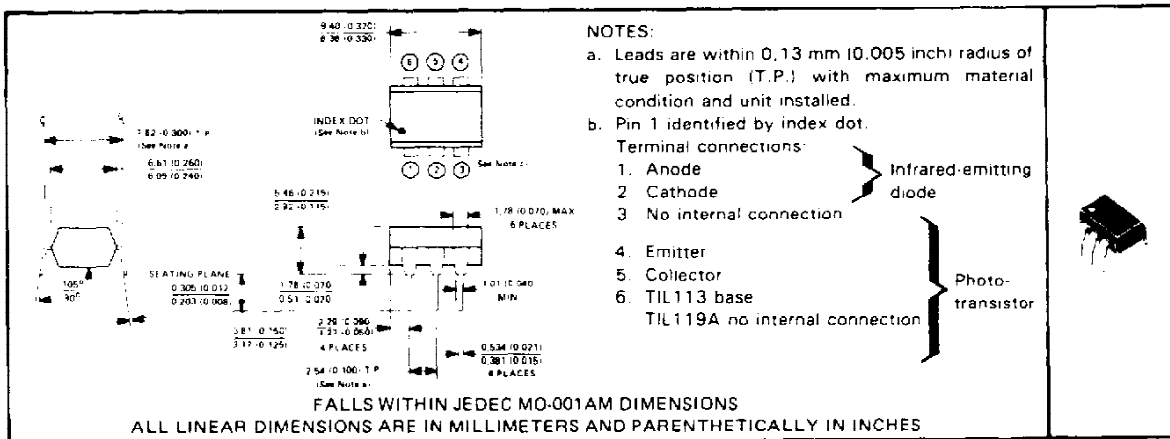

absolute maximum ratings at 25°C free-air temperature (unless otherwise noted)

Input-to-Output Voltage	±1.5 kV
Collector-Base Voltage (TIL113)	30 V
Collector-Emitter Voltage (See Note 1)	30 V
Emitter-Collector Voltage	7 V
Emitter-Base Voltage (TIL113)	7 V
Input-Diode Reverse Voltage	3 V
Input-Diode Continuous Forward Current at (or below) 25°C Free-Air Temperature (See Note 2)	100 mA
Continuous Power Dissipation at (or below) 25°C Free-Air Temperature:	
Infrared-Emitting Diode (See Note 3)	150 mW
Phototransistor (See Note 4)	150 mW
Total (Infrared-Emitting Diode plus Phototransistor, See Note 5)	250 mW
Storage Temperature Range	-55°C to 150°C
Lead Temperature 1.6 mm (1/16 Inch) from Case for 10 Seconds	260°C

- NOTES:**
- This value applies when the base-emitter diode is open circuited.
 - Derate linearly to 100°C free-air temperature at the rate of 1.33 mW/°C.
 - Derate linearly to 100°C free-air temperature at the rate of 2 mW/°C.
 - Derate linearly to 100°C free-air temperature at the rate of 2 mW/°C.
 - Derate linearly to 100°C free-air temperature at the rate of 3.33 mW/°C.

PRODUCTION DATA documents contain information current as of publication date. Products conform to specifications per the terms of Texas Instruments standard warranty. Production processing does not necessarily include testing of all parameters.

**TEXAS
INSTRUMENTS**
 POST OFFICE BOX 655303 • DALLAS, TEXAS 75285

Copyright © 1989, Texas Instruments Incorporated

TIL113, TIL119A OPTOCOUPLEDERS

electrical characteristics at 25°C free-air temperature

PARAMETER	TEST CONDITIONS†	TIL113			TIL119A			UNIT
		MIN	TYP	MAX	MIN	TYP	MAX	
$V_{(BR)CBO}$	Collector-Base Breakdown Voltage $I_C = 10 \mu A, I_E = 0, I_F = 0$	30						V
$V_{(BR)CEO}$	Collector-Emitter Breakdown Voltage $I_C = 1 mA, I_B = 0, I_F = 0$	30			30			V
$V_{(BR)EBO}$	Emitter-Base Breakdown Voltage $I_E = 10 \mu A, I_C = 0, I_F = 0$	7						V
$V_{(BR)ECO}$	Emitter-Collector Breakdown Voltage $I_E = 10 \mu A, I_F = 0$				7			V
$I_{C(on)}$	On State Collector Current $V_{CE} = 1 V, I_B = 0, I_F = 10 mA$	30	100					mA
	$V_{CE} = 1 V, I_F = 10 mA$				30	160		
$I_{C(off)}$	Off-State Collector Current $V_{CE} = 10 V, I_B = 0, I_F = 0$			100			100	nA
β_{FE}	Transistor Static Forward Current Transfer Ratio $V_{CE} = 1 V, I_C = 10 mA, I_F = 0$		15,000					
V_F	Input Diode Static Forward Voltage $I_F = 10 mA$			1.5			1.5	V
$V_{CE(sat)}$	Collector-Emitter Saturation Voltage $I_C = 125 mA, I_B = 0, I_F = 50 mA$			1.2				V
	$I_C = 30 mA, I_F = 10 mA$						1	
r_{IO}	Input-to-Output Internal Resistance $V_{in-out} = \pm 1.5 kV$. See Note 6		10^{11}			10^{11}		Ω
C_{io}	Input-to-Output Capacitance $V_{in-out} = 0, f = 1 MHz$. See Note 6		1	1.3		1	1.3	pF

NOTE 6: These parameters are measured between both input-diode leads shorted together and all the phototransistor leads shorted together. †Reference to the base are not applicable to TIL119A.

switching characteristics at 25°C free-air temperature

PARAMETER	TEST CONDITIONS	TIL113			TIL119A			UNIT
		MIN	TYP	MAX	MIN	TYP	MAX	
t_r	Rise Time $V_{CC} = 15 V, I_{C(on)} = 125 mA, R_L = 100 \Omega$		300					μs
t_f	Fall Time $R_L = 100 \Omega$. See Figure 1		300					μs
t_r	Rise Time $V_{CC} = 10 V, I_{C(on)} = 2.5 mA, R_L = 100 \Omega$					300		μs
t_f	Fall Time $R_L = 100 \Omega$. See Figure 1					300		

PARAMETER MEASUREMENT INFORMATION

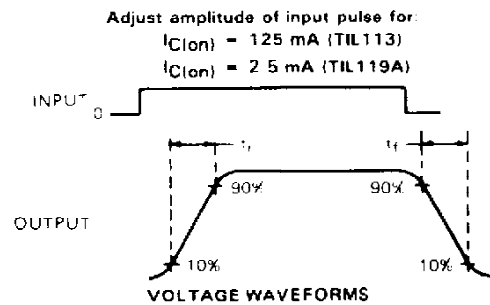
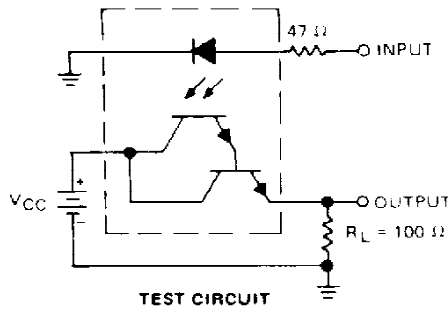

- NOTES: a. The input waveform is supplied by a generator with the following characteristics: $Z_{out} = 50 \Omega, t_r = 15 ns, duty\ cycle = 1\%, t_w = 500 \mu s$.
 b. The output waveform is monitored on an oscilloscope with the following characteristics: $t_r = 12 ns, R_{in} = 1 M\Omega, C_{in} = 20 pF$.

FIGURE 1—SWITCHING TIMES

TYPICAL CHARACTERISTICS

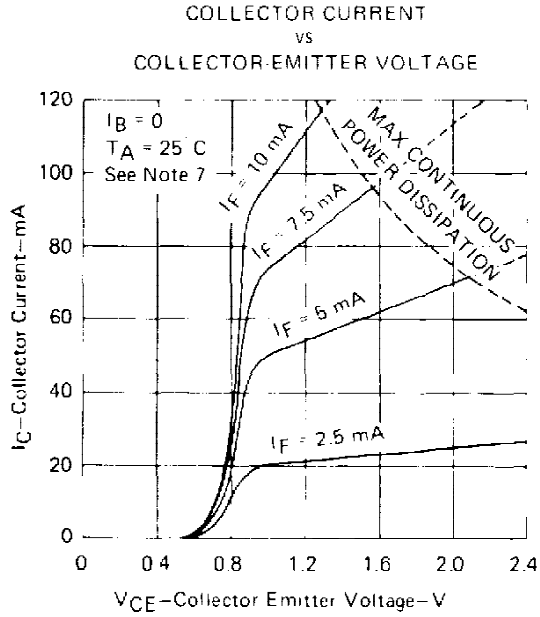

FIGURE 2

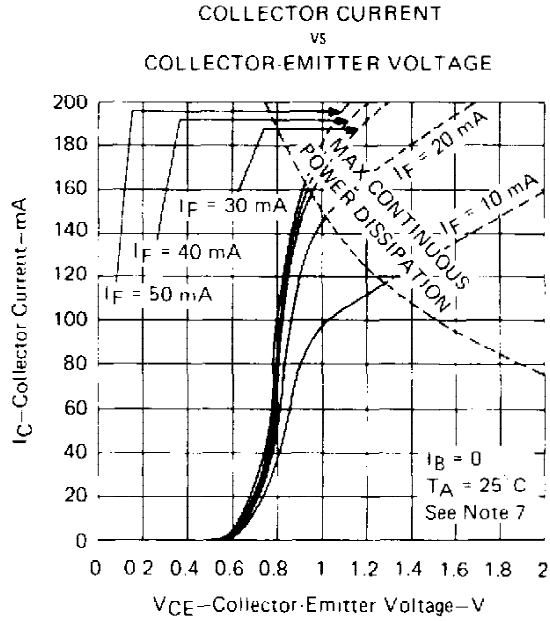

FIGURE 3

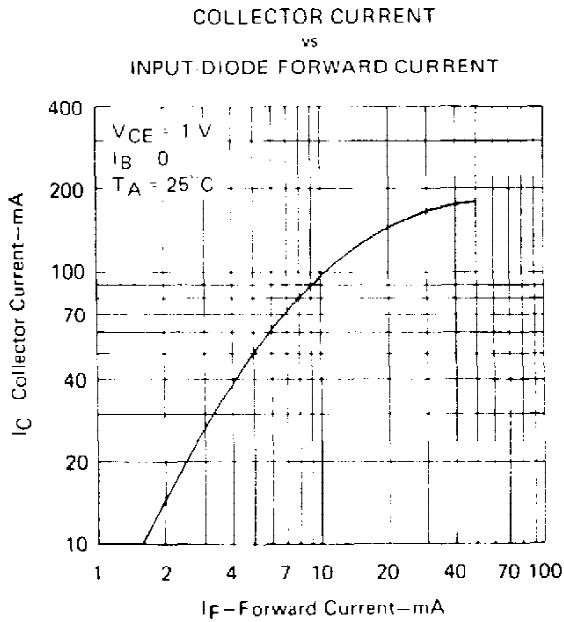

FIGURE 4

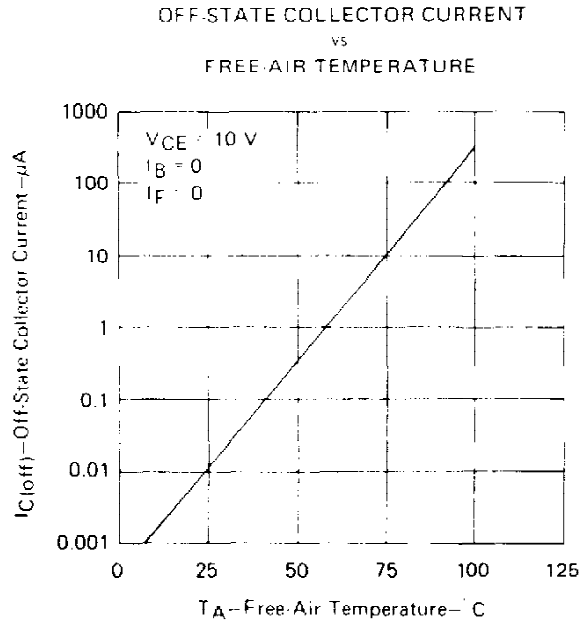

FIGURE 5

NOTE 7. Pulse operation of input diode is required for operation beyond limits shown by dotted line.

**TIL113, TIL119A
OPTOCOUPERS**

TYPICAL CHARACTERISTICS

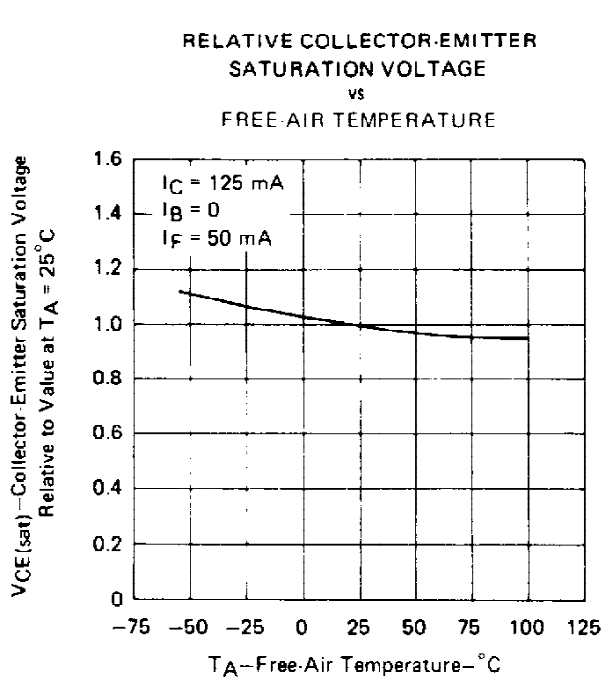

FIGURE 6

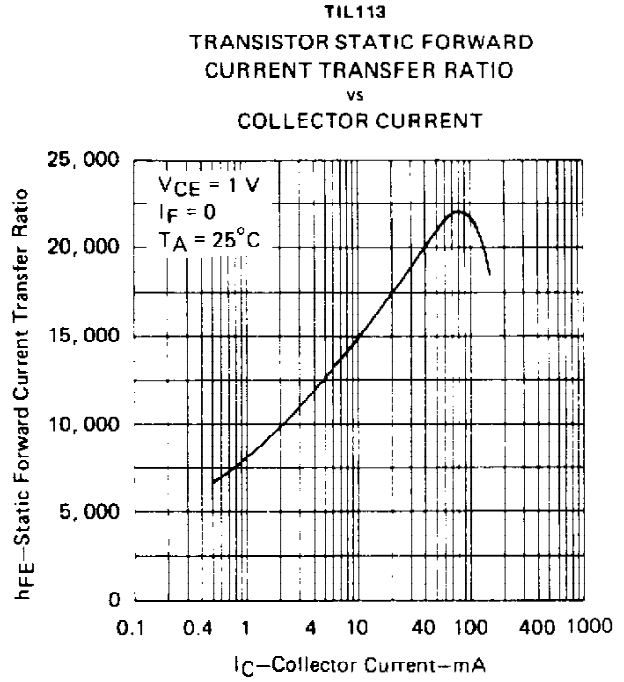

FIGURE 7

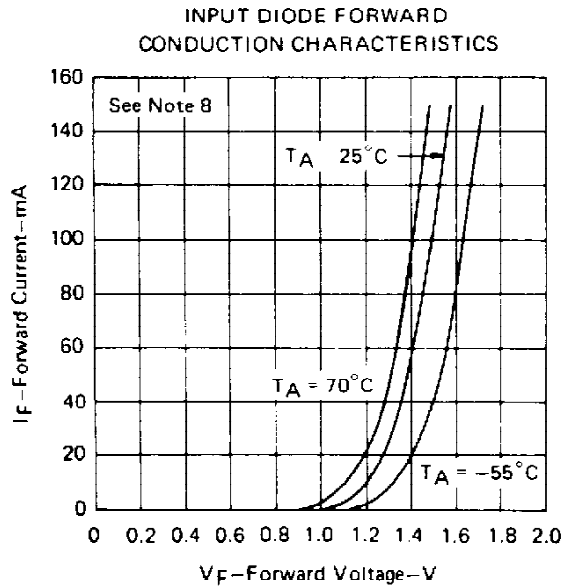

FIGURE 8

NOTE 8: This parameter was measured using pulse techniques. $t_w = 1\text{ ms}$, duty cycle $\leq 2\%$.

IMPORTANT NOTICE

Texas Instruments (TI) reserves the right to make changes to its products or to discontinue any semiconductor product or service without notice, and advises its customers to obtain the latest version of relevant information to verify, before placing orders, that the information being relied on is current.

TI warrants performance of its semiconductor products and related software to the specifications applicable at the time of sale in accordance with TI's standard warranty. Testing and other quality control techniques are utilized to the extent TI deems necessary to support this warranty. Specific testing of all parameters of each device is not necessarily performed, except those mandated by government requirements.

Certain applications using semiconductor products may involve potential risks of death, personal injury, or severe property or environmental damage ("Critical Applications").

TI SEMICONDUCTOR PRODUCTS ARE NOT DESIGNED, INTENDED, AUTHORIZED, OR WARRANTED TO BE SUITABLE FOR USE IN LIFE-SUPPORT APPLICATIONS, DEVICES OR SYSTEMS OR OTHER CRITICAL APPLICATIONS.

Inclusion of TI products in such applications is understood to be fully at the risk of the customer. Use of TI products in such applications requires the written approval of an appropriate TI officer. Questions concerning potential risk applications should be directed to TI through a local SC sales office.

In order to minimize risks associated with the customer's applications, adequate design and operating safeguards should be provided by the customer to minimize inherent or procedural hazards.

TI assumes no liability for applications assistance, customer product design, software performance, or infringement of patents or services described herein. Nor does TI warrant or represent that any license, either express or implied, is granted under any patent right, copyright, mask work right, or other intellectual property right of TI covering or relating to any combination, machine, or process in which such semiconductor products or services might be or are used.

IMPORTANT NOTICE

Texas Instruments and its subsidiaries (TI) reserve the right to make changes to their products or to discontinue any product or service without notice, and advise customers to obtain the latest version of relevant information to verify, before placing orders, that information being relied on is current and complete. All products are sold subject to the terms and conditions of sale supplied at the time of order acknowledgement, including those pertaining to warranty, patent infringement, and limitation of liability.

TI warrants performance of its semiconductor products to the specifications applicable at the time of sale in accordance with TI's standard warranty. Testing and other quality control techniques are utilized to the extent TI deems necessary to support this warranty. Specific testing of all parameters of each device is not necessarily performed, except those mandated by government requirements.

CERTAIN APPLICATIONS USING SEMICONDUCTOR PRODUCTS MAY INVOLVE POTENTIAL RISKS OF DEATH, PERSONAL INJURY, OR SEVERE PROPERTY OR ENVIRONMENTAL DAMAGE ("CRITICAL APPLICATIONS"). TI SEMICONDUCTOR PRODUCTS ARE NOT DESIGNED, AUTHORIZED, OR WARRANTED TO BE SUITABLE FOR USE IN LIFE-SUPPORT DEVICES OR SYSTEMS OR OTHER CRITICAL APPLICATIONS. INCLUSION OF TI PRODUCTS IN SUCH APPLICATIONS IS UNDERSTOOD TO BE FULLY AT THE CUSTOMER'S RISK.

In order to minimize risks associated with the customer's applications, adequate design and operating safeguards must be provided by the customer to minimize inherent or procedural hazards.

TI assumes no liability for applications assistance or customer product design. TI does not warrant or represent that any license, either express or implied, is granted under any patent right, copyright, mask work right, or other intellectual property right of TI covering or relating to any combination, machine, or process in which such semiconductor products or services might be or are used. TI's publication of information regarding any third party's products or services does not constitute TI's approval, warranty or endorsement thereof.