

# SCHEMATIC DIAGRAM

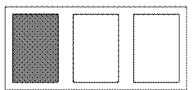

D

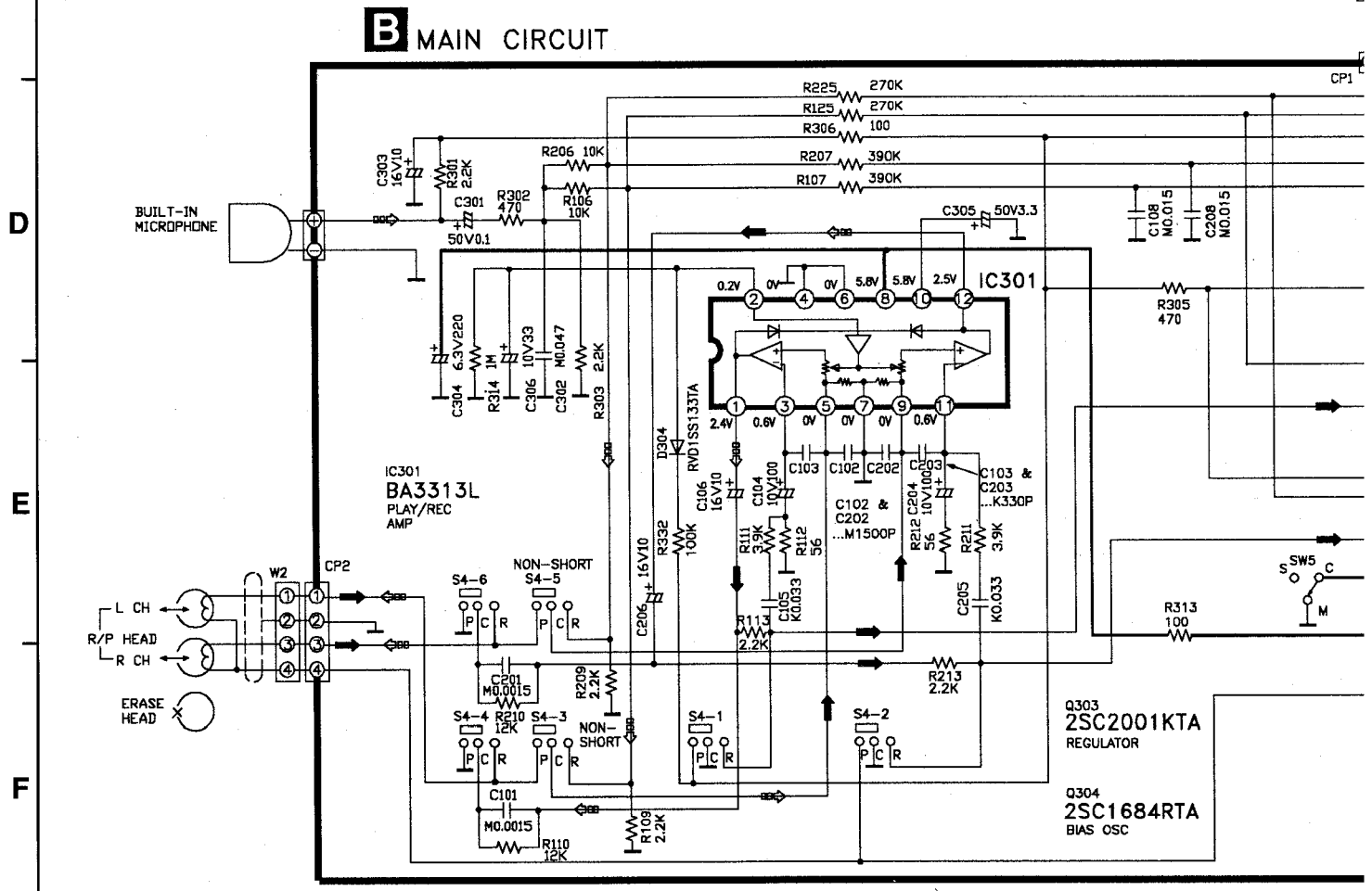
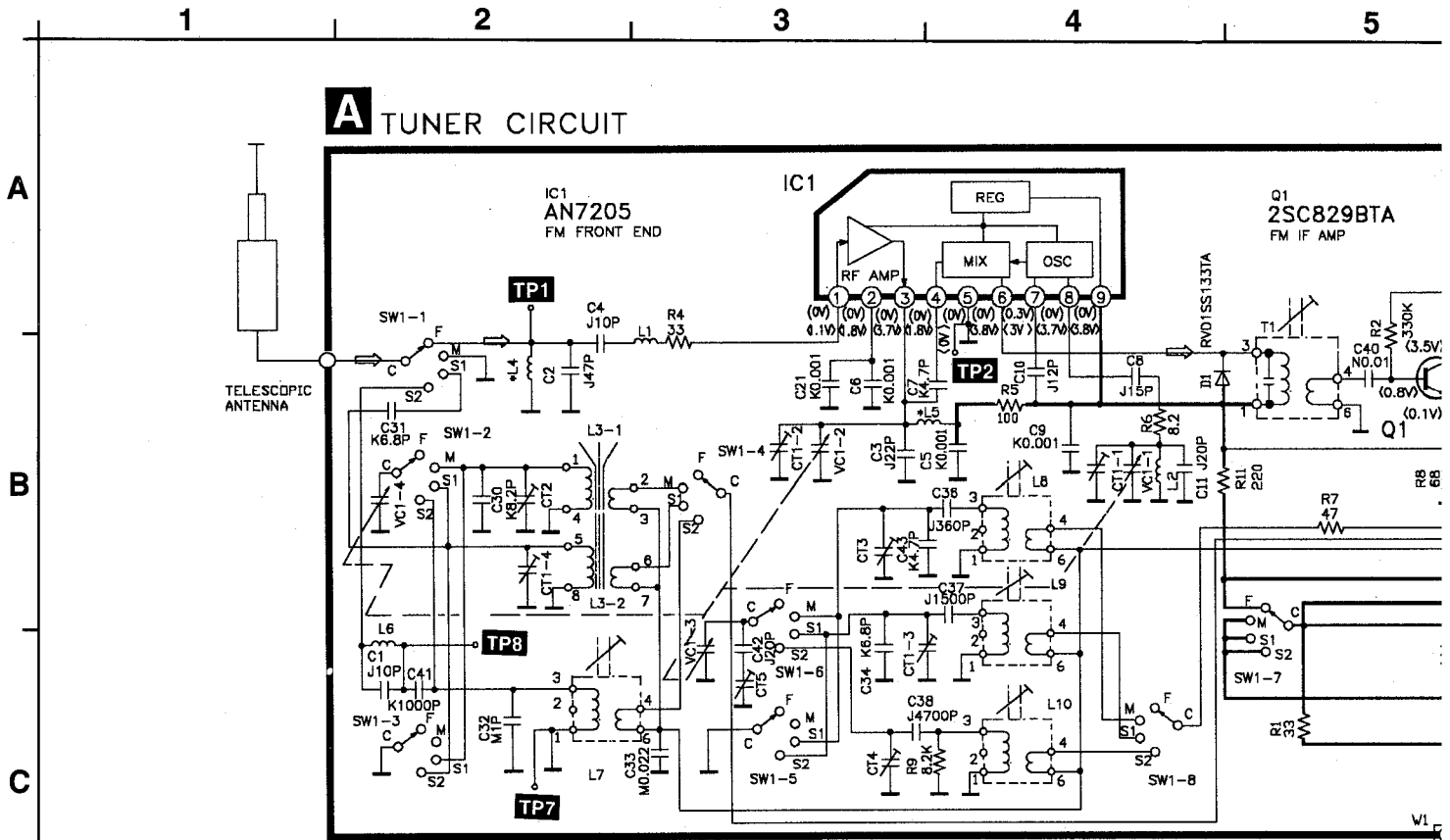
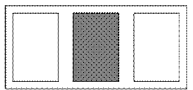
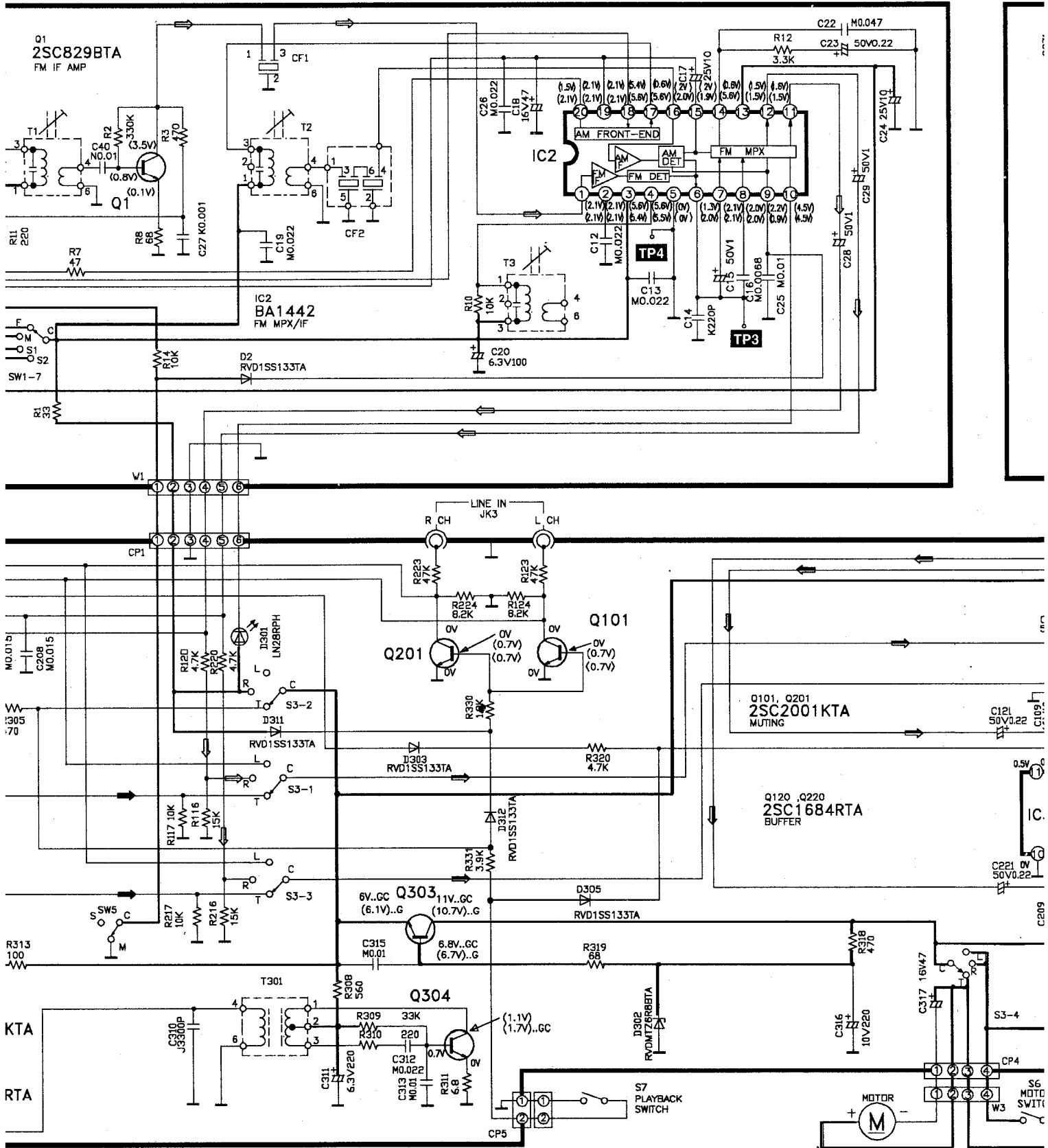

# D G.E.Q. CIRCUIT

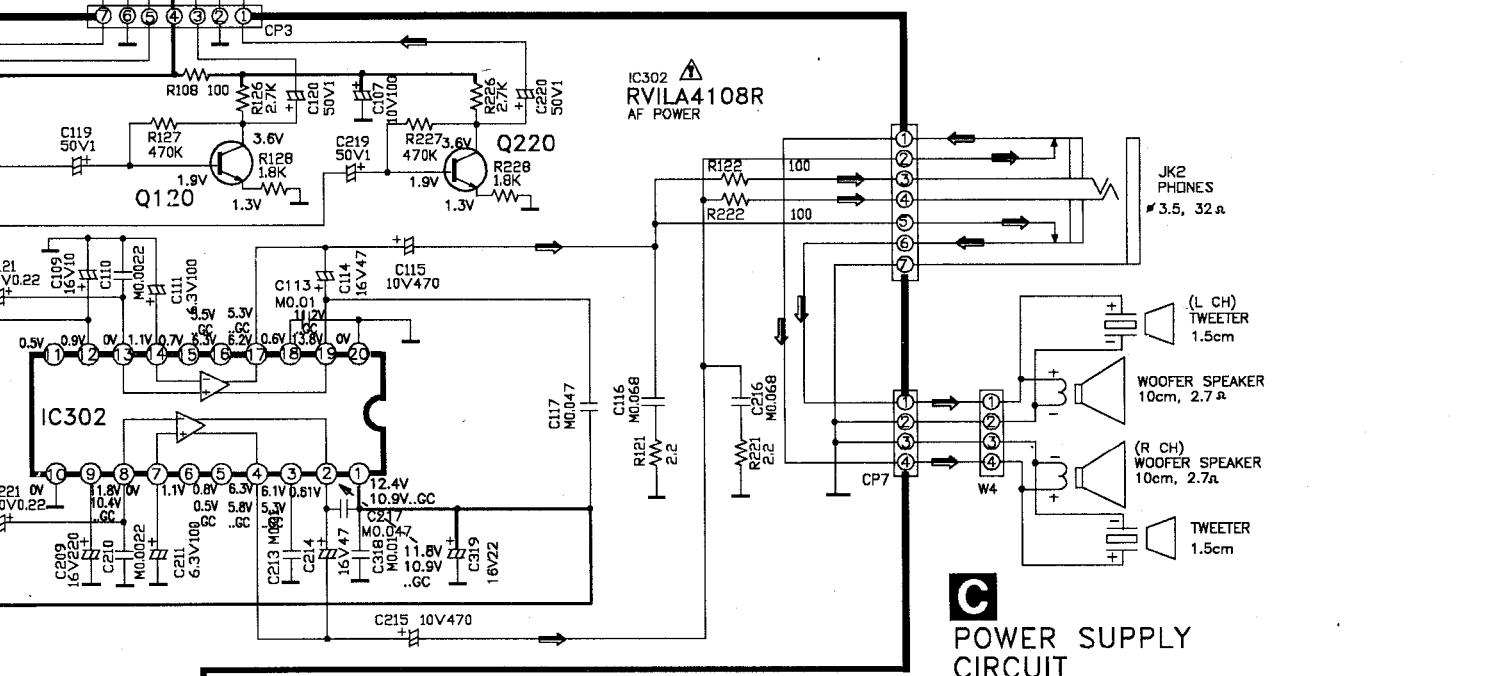
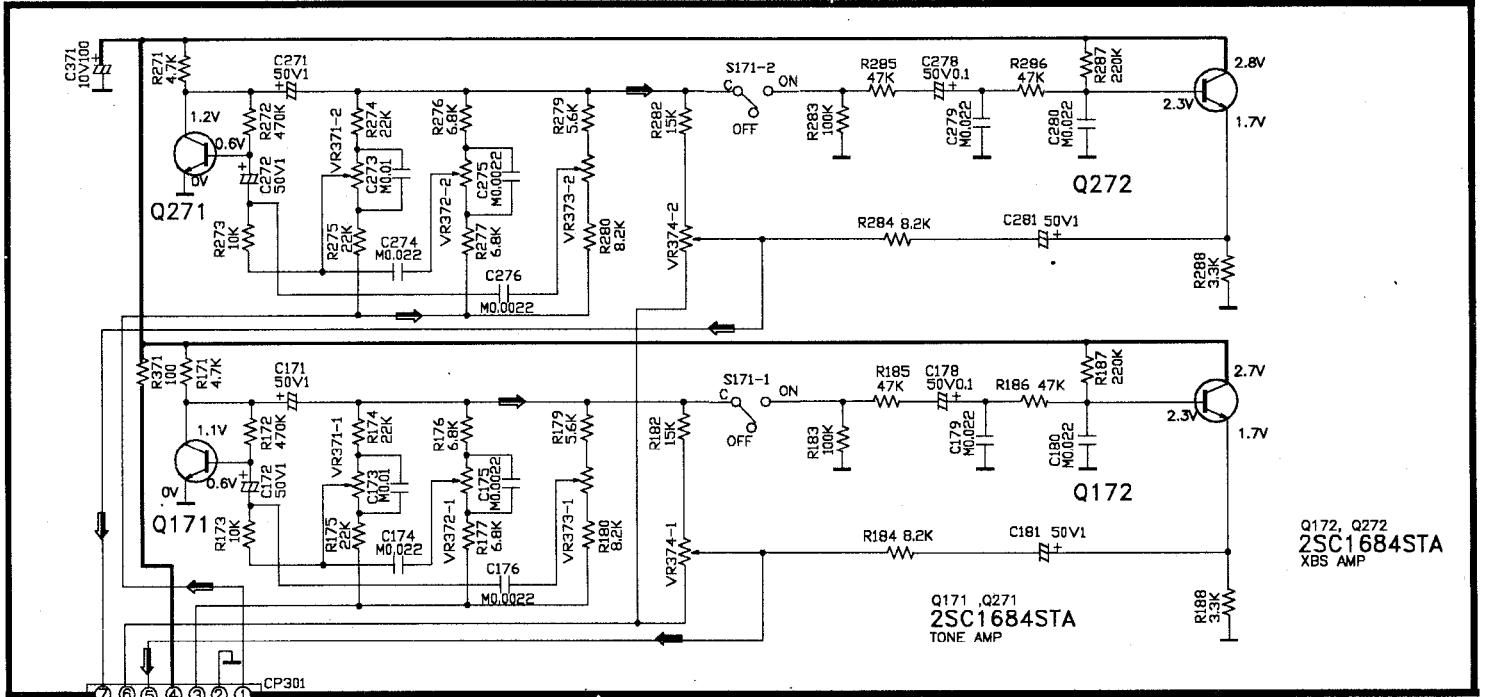

# C POWER SUPPLY CIRCUIT

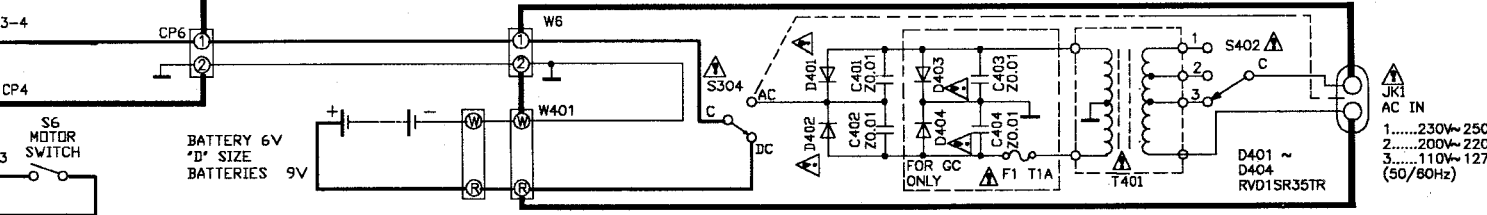

- 1.....230V~ 250V
- 2.....200V~ 220V
- 3.....110V~ 127V (50/60Hz)

