



## Saving the Sony CDP-101 CD Player

With an Appendix Covering the CDP-200

*Copyright © 2010 by Stephen H. Lafferty. All rights reserved. Rev-3*

In early 1983, I was a design engineer at Wegener Communications, working on the design of a revolutionary satellite communications system. For the first time (as far as we knew), this system would enable network providers to distribute extremely high-fidelity audio over the satellite. This was called the Panda-II System, based on the development of an advanced and highly accurate compander, known as the Panda-II. Years before, we had developed a simpler compander, the Panda-I (**at right**), which became the satellite broadcasting standard in Europe. It was also quite widely used in the United States.



But as we readied prototypes of the Panda-II, we had a problem: There was no source content that we could get, which would demonstrate the awesome, 90-dB dynamic range of the system. When Sony released the first CD player in the U.S. that year, the CDP-101, it was a godsend. Wegener did everything it could to get one as soon as possible, as they were quite rare, at first. When at last our unit arrived, we were told that it was the first one in Georgia.

It turned out to be everything we had hoped-for and more. Sony had done it right: 5Hz to 20kHz frequency response, flat to 0.5dB, 90dB signal-to-noise ratio (SNR), 0.004% harmonic distortion and no wow & flutter. The only thing lacking was much in the way of CD's. The first album commercially released on CD was Billy Joel's, *52nd Street*, and another of his albums became our standard test CD for the compander development. In fact, I remember that the song, "Allentown" was the toughest one for the compander to handle, due to isolated high-frequency transients. After considerable effort, Panda-II was able to handle any transient we could devise. It was patented and went into production, later beating a new digital system in customer listening tests. The CDP-101 played a key role in those tests. In 1985, Panda-II brought CD-quality television audio from the Live Aid concert to the U.S., thanks in part, to the pioneering Sony player.

## Hidden Weakness

Little did we know, as we avidly used the CDP-101, that inside it had a hidden weakness, which was slowly degrading the player. It has since come to light that the modular servo amplifiers (STK6922) used in the unit are prone to failure. To make matters worse, those parts have become hard to find. (More about that later.) Also, long before they fail, they may cause degraded operation. This could account for a couple comments about bad sound which I have seen on the Web

about the player. When it is working correctly, it's hard to imagine anyone complaining about the sound of the CDP-101. It is very close to perfection.

That is not to say that there is anything necessarily wrong with the STK6922. In working on the player, I have discovered that the module can get uncomfortably hot to the touch. It could very well be that the stressful heating is causing the unusually high failure rate. A classic rule of thumb is that the failure rate doubles for every 10°C increase in temperature. In my opinion, Sony should have used a larger heatsink on at least the focus and tracking amps (IC204).

The load on these amps measures 9.3-ohms and 8.3-ohms, respectively. They typically put out 0.5V to 1V with peaks up to  $\pm 2V$ . However, they *can* put out  $\pm 9V$  or so. The small heatsink provided on IC204 (**seen at right**) is not adequate for the higher levels. If the particular CD being played is a bit warped, the servo might be called upon to drive much harder than is typical. High ambient temperatures would aggravate the situation.

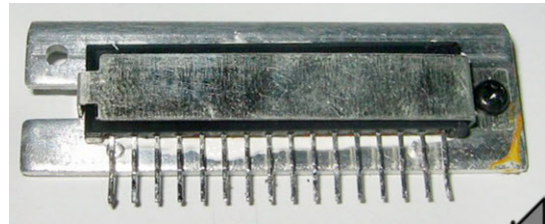

## Cooling the Servo Amp

Unfortunately, the inside of the player is pretty packed, so there isn't a great deal of room for a larger heatsink. My solution is shown in the sketch of the U-shaped heatsink **at right**. The amp module is in blue. Grays are a piece of aluminum sheet metal which has been cut and bent to conform to the space available inside the chassis. The amp module is shown upside down because the PCB on which it resides is upside down in the unit.

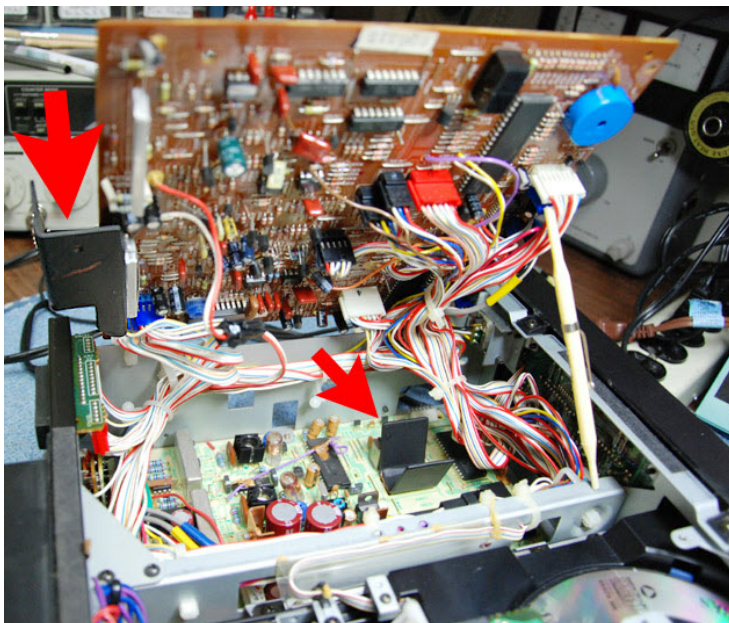
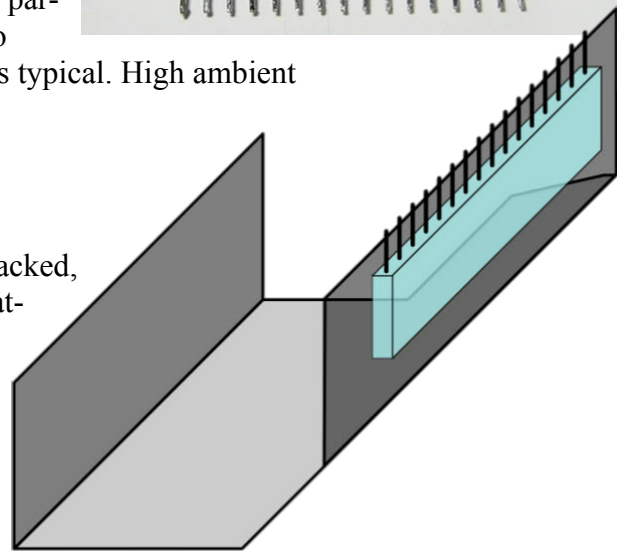

To improve heat dissipation, the left, upright panel of the heatsink is flush against the rear panel of the player chassis. Part of the horizontal area in the foreground overlays an existing horizontal bulkhead. It could be screwed to that for additional cooling. I did not find that necessary, though. With this heatsink in place, it and the amp module only get modestly warm to the touch, a big improvement.

You can see the heatsink *in situ* **at left**, pointed-out by the larger arrow. Notice how it is shaped to allow for the small PCB on the rear panel of the unit. As the amp's PCB is swung

down, it must be pulled forward to allow the heatsink to get under the lip at the top of the rear panel. **At right**, is a view from above, with the board and heatsink in-place.

**Below right**, is a close-up photo of the heatsink and amp module. Notice that a similar amp module (sled and loading amps) above does not need additional heatsinking because it sees lighter duty. Sharp eyes will notice that the amp modules in this photo look a bit different from the one in the top photo of the previous page. That is because the ones pictured here are actually the BX-1201, which is a direct replacement for the STK6922. We will get into construction details of the focus and tracking servo amp heatsink a little later. But first...

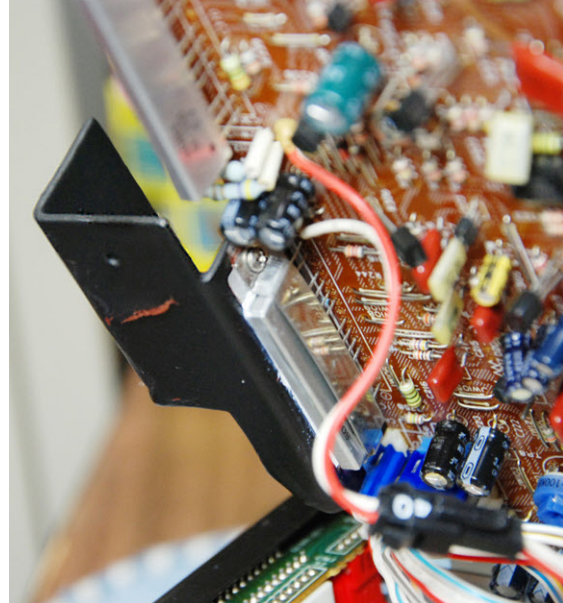
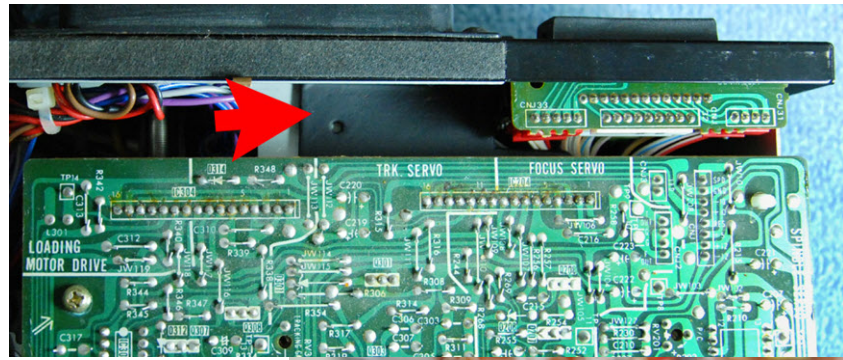

## Heatsink for the RAM Control Chip

While debugging other problems with a CDP-101, I noticed that one of the chips of the digital data processor also runs hot: IC503, RAM Control. This is a 70-pin flat-pak, which is surface-mounted in a rectangular hole in the PCB; pretty advanced packaging for a 1983 consumer product. Since that chip would be very difficult to replace, I thought it important to control its temperature to extend its life. Fortunately, a heatsink for it can be much simpler. You can see a glimpse of it on the previous page (smaller arrow). **At left** is a closer view.

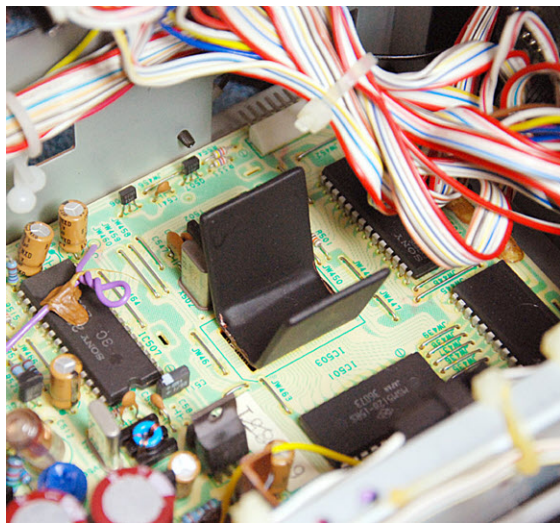

It is formed from 0.0625" copper sheet metal. I obtained the material by splitting copper water pipe but that is the hard way. The heatsink should be painted flat black. Odd as it may seem to those not familiar, the paint improves emissivity. However, you should mask the surface which contacts the chip, as that will need to make a good epoxy bond.

The drawing **at right** shows the dimen-

sions. Bend the wings about 45-60° with respect to the horizontal plane.

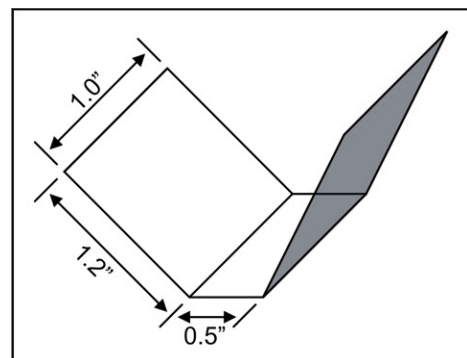

The next step is to attach the heatsink to IC503. You can see the chip in the center of the photo **at right**. [This pic is from a CDP-200 but this portion of the unit is similar to the CDP-101.]

I used 5-minute epoxy for the bond. Use only a small amount, keeping the layer between the heatsink and chip, thin. To avoid making a mess and preventing the chip from being

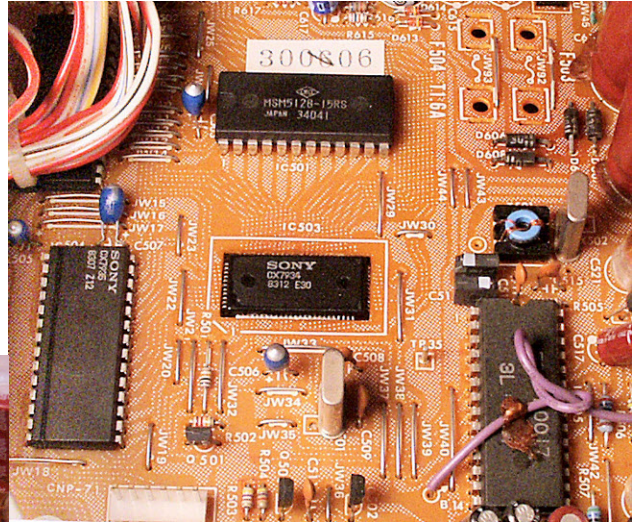
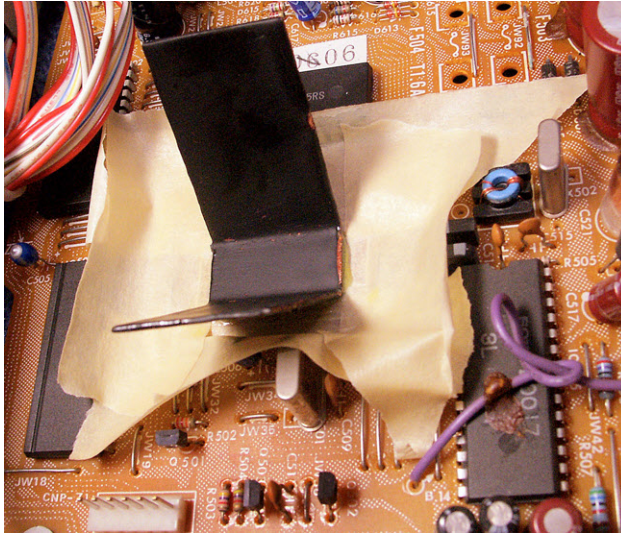

changed, we must mask the surrounding area, **as shown at left**. Note that the fins used in this example were a bit longer than those specified in the previous page.

## Fabricating a Replacement and Heatsink for the STK6922

We return now to the earlier discussion of the heatsink for the servo amp, for which details were promised. The reason that the construction details were put off until now, is that we also wanted to cover the integrated fabrication of a replacement for the STK6922 servo amp. If your amp has already succumbed to the heat stresses, you might find as I did, that replacements are not available. Actually, when I last checked several years ago, one vendor did accept an order for that part. Every month for several months, the delivery was postponed a month, so I finally canceled the order.

Recently, I have found another vendor offering the part, from a link at Adrian Kingston's site: <http://www.ciconelectronics.com/stk6922.html> and have placed an order with them. We will see. In the event that doesn't pan out or the part later becomes extinct, the design discussed below is offered as a way to get a replacement. In any case, the heatsink itself can be useful with the original part as well.

## The Amplifier Design

From the measured operating parameters (given on page-2), I could see that an audio power amplifier which also had opamp-like characteristics, would be suitable to perform the servo function. I settled on using the popular and inexpensive LM1875 20W audio power amp chip. It meets all the requirements to replace the STK6922 and comes in a TO-220 size package with five pins. In the CDP-101, the STK6922 is supplied with regulated  $\pm 12V$  supplies as well as unregulated supplies labeled  $\pm 10V$ . These actually run about  $+13V$ ,  $-14.5V$ . The regulated supplies were to run lower-level functions of the amp and the unregulated supplies would run the

output stage. The LM1875 does not need the low-level supplies and has good enough supply rejection to operate off the unregulated supplies. So we can ignore the  $\pm 12V$  pins of the STK7922.

The circuit for using two LM1875's to replace the STK7922 is shown **at right**. Caps are all 0.22 uF and the resistors are one ohm. Nothing special here. The output loading components are specified in the datasheet for high frequency stability. Power supply bypassing is provided. The external pin numbers correspond to those of the STK7922.

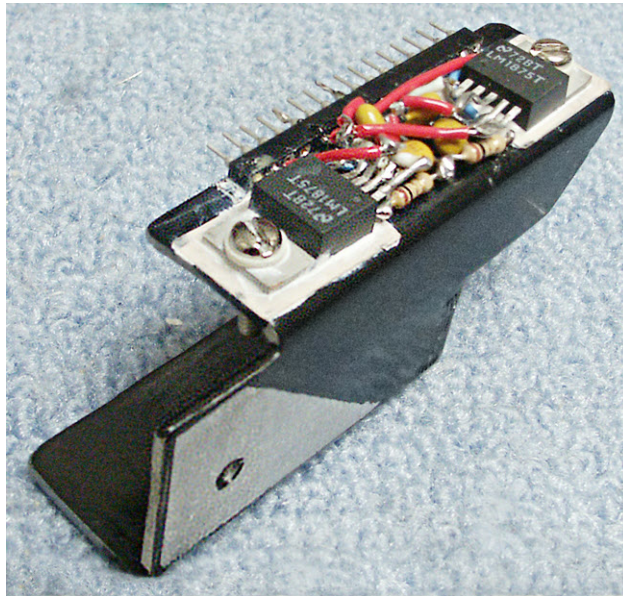
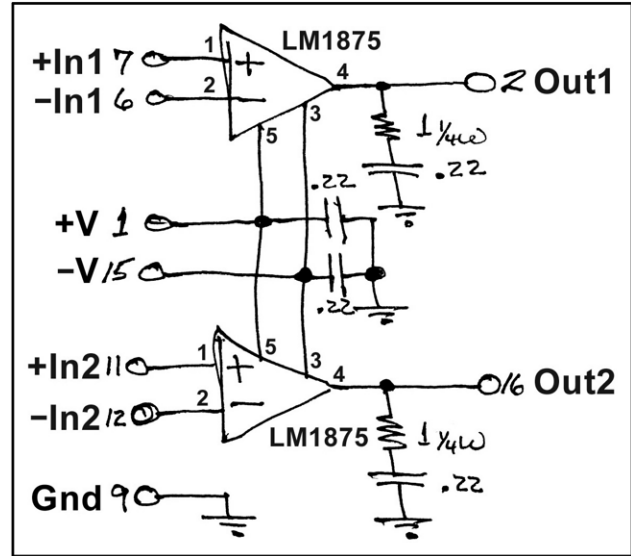

As shown **at left**, the servo amp is constructed on the aluminum heatsink. Of course, the circuitry is added after the heatsink has been cut, bent and painted.

### Making the Servo Heatsink

We will now cover the steps in making the heatsink itself. If you are making it for use with the STK7922 or BX1201 servo amp part,

use the drawing **at right**. (Below, we will cover a slightly different version for use with the DIY replacement circuit.) The arrows show how the sides are bent up to form a U-shape. Aluminum, 0.0625" sheet metal is the material. The servo amp is mounted on the opposite side from the one we are viewing. The slot and hole work with the existing amp mounting hardware which you can see in the upper pic on page-2.

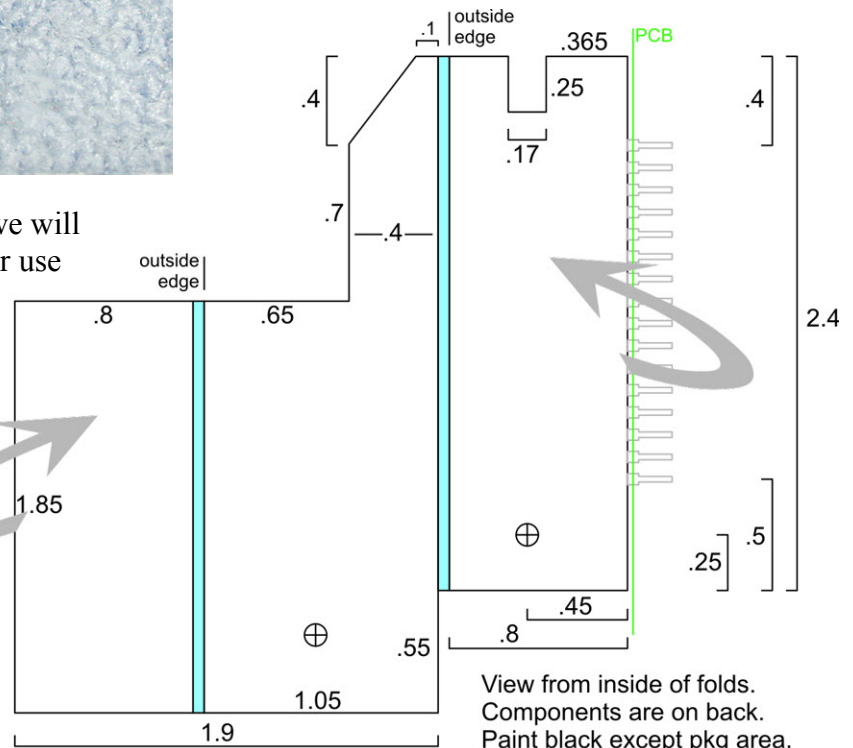

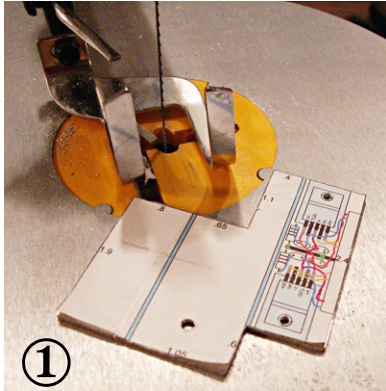

①

**At left**, the sheet metal is cut using a scroll saw with a metal-blade. I used a paper template, pasted to the metal. Not sure if that was really better than just scribing the piece. The example here is the DIY replacement amp version but the original amp version is similar. The main difference is in adding a slot.<sup>1</sup>

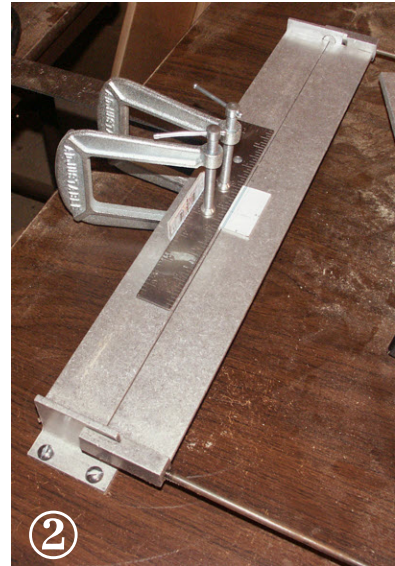

②

**At right**, a bending brake is about to do the second bend. To accommodate the narrow bottom of the piece, I have improvised a nose bar on top using a square. (I doubt my dad would have approved of that :)

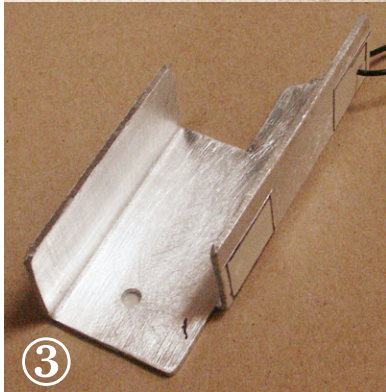

③

**Left**, the piece is sanded and masked for painting. The masking

would be a solid strip for the original amp version.



⑤

After painting and drying **at right**, the finished piece is shown **at left**. Note that the

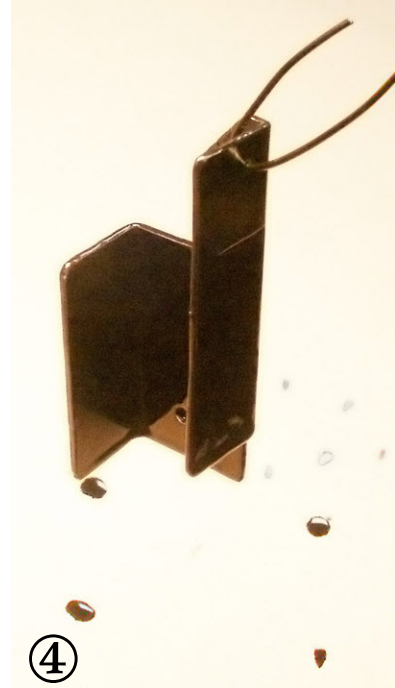

④

trapezoidal mask and hole on top (which will be oriented to the bottom) was only used in anticipation of securing the heatsink to the internal bulkhead. That wasn't found to be needed for heat dissipation, so that mask and hole can be omitted.

## Installing the Servo Heatsink

If you are just adding the heatsink to the existing servo amp part, installation is easy. Remove the two screws holding the player's Servo Amp Board (top board) down. It will pivot up. Remove the screw holding IC204 to its existing heatsink strip, saving the mounting hardware. Clean-off the dried heatsink grease from IC204 and add new grease to it. Attach the new heatsink with the

<sup>1</sup>To add the slot as seen in the figure at the bottom of page-5, cut the sides of the slot with the scroll saw. Bend the tongue out with needle-nose pliers and cut it off with diagonal cutters. Use a Dremel to grind the stub. Finish with a small, triangular file.

old mounting hardware. Lower the Servo Amp Board back into position. To do that, you will need to bend IC204 forward so the heatsink can slip by the upper lip of the rear panel. That is okay for this one time. If you should need to pull the board back up in the future though, I recommend that you pop-out the two nylon fasteners which hold the board on the pivot side. Then pull the board forward to allow the heatsink to clear the lip of the rear panel.

## Building a Replacement for the STK7922

If you need to replace IC204, use the heatsink fabrication drawing **above right** instead of the one on page-5. This one substitutes mounting holes for the

LM1875 devices in place of the slot and hole for mounting the STK7922. Note that the lower hole position is slightly different from the hole for the STK7922. Also, be aware that the LM1875's and other components are mounted on the opposite side from the one we are viewing. (Hence, the reversed labeling on the LM1875's.)

The heatsink is fabricated as shown on the previous page. The next step is to glue the pins to the heatsink (shown **at right**). The pins are made from a 16-pin DIP socket. Before applying 5-minute epoxy, mask the area to be glued so the epoxy will not spread where it isn't wanted. The mask also serves to guide positioning the pins.

Next mount the two LM1875's, using insulating kits to electrically isolate the packages from the heatsink. Use heatsink grease. Solder the wiring connections and components to complete the circuit. Note that the diagram *above* is an "X-Ray view" through the heatsink, so it is

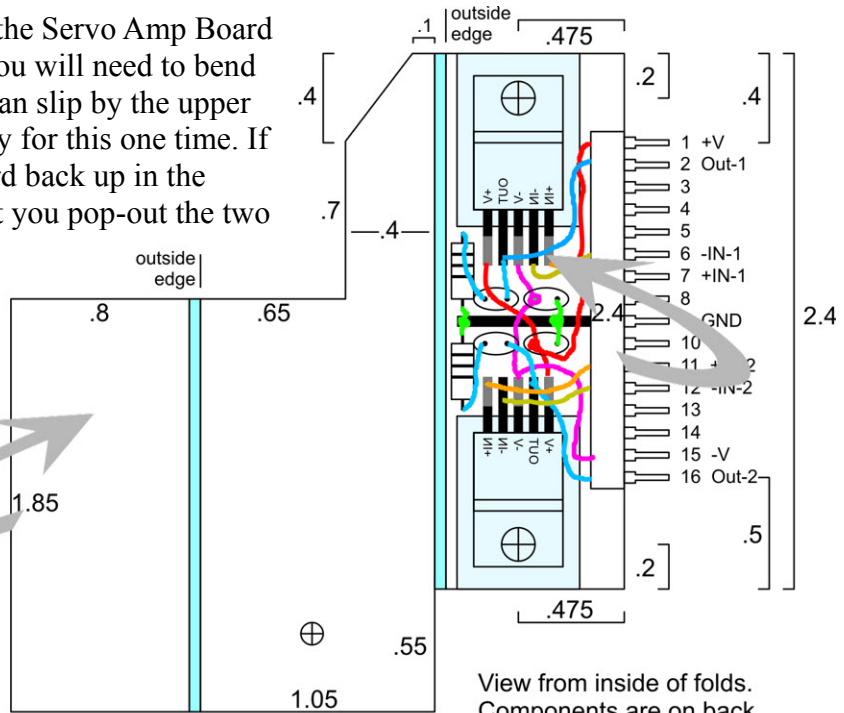
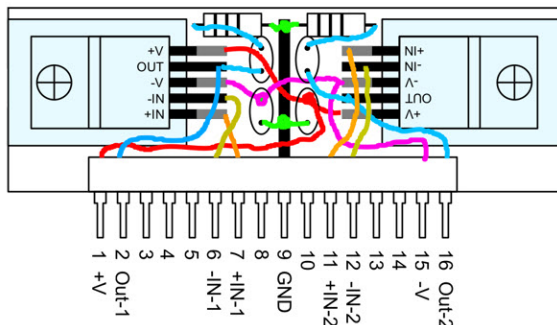

View from inside of folds. Components are on back. Paint black except pkg area.

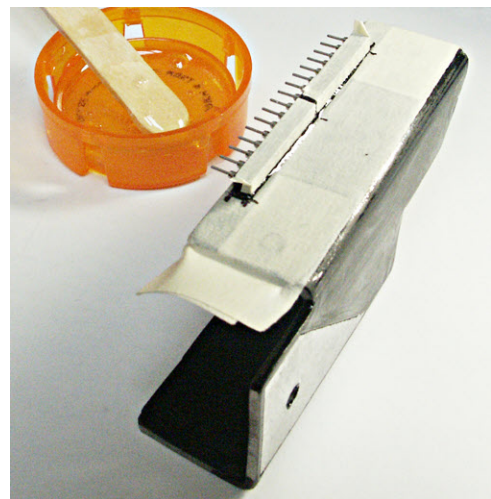

reversed relative to the view from the component side. Use the un-reversed diagram **at left**, the photo **below** and the schematic as wiring guides.



## Installing the Replacement Servo Amp

After removing the old STK6922, solder the pins of the new construction in its place, as shown **at right**. Next, we will lower the Servo Amp Board back into position. Unlike the original servo amp parts, the pins on our new construction *will not bend safely*. We need to slip the heatsink by the upper lip of the rear panel, though.

You will need to pop-out the two nylon fasteners which hold the board at its pivot. Pull the board forward to allow the heatsink to clear the lip of the rear panel. Then push it down into place. When seated properly, the view of the heatsink at the rear panel looks like the photo **below**:

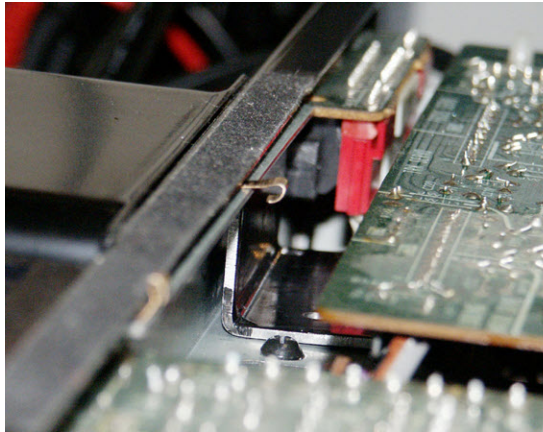

That completes the replacement procedure. Since the focus and tracking servo amps have local feedback which sets their gain, there should not be a need for readjustments, due to the replacement.

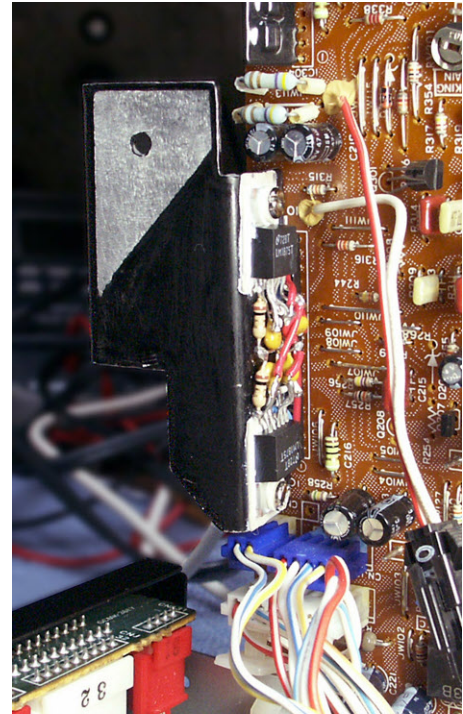

## Clearing the Top Vents

The photo **at left** shows one of the top vents of the player, as viewed from the inside. Much of the already meager vent area is restricted by thin copper EMI shielding. The large power transformer for the unit indicates that there is substantial power dissipation in the player. In view of that, I feel that the vent restrictions are bad for the reliability of the unit. EMI shielding is a soft issue which doesn't affect audio quality. I have never found EMI problems from digital circuitry such as the CDP-101 has, so I removed the copper foil as seen in the **lower photo**

**above**. The foil is sandwiched between top panel layers and can be torn out.

I hope that the mods provided here work out well for you. If you have any questions or comments, I will try to help. You can reach me at: [slafferty@bellsouth.net](mailto:slafferty@bellsouth.net)

## Acknowledgement

I would like to thank Adrian Kingston for permission to use the top photo on page-2. He has an excellent web page on the CDP-101, which you can see at: <http://www.adrian-kingston.com/CDP-101.htm>



## Appendix: Adding Heatsinks to the Sony CDP-200

The CDP-200 (**at right**) was a cost-reduced follow-on model which Sony introduced in October, 1983. It reportedly sold for about \$700, which would make it \$300 cheaper than the CDP-101 when it was introduced. The CDP-200 used the same optical pickup and some of the same circuitry as the CDP-101 did. In fact, as we noted on page-4, we used a photo from the CDP-200 to illustrate the heatsink for IC503 in the CDP-101. Of course, you can follow those instructions for the CDP-200 as well.



By the way, you might have noticed that the lower PCB in the CDP-101 at the bottom of page-3 is light-colored epoxy-glass, whereas the one in the CDP-200 on page-4 is cheaper phenolic. The upper servo board however, differed in layout between the two units. The focus and tracking servo amp was moved from the back, to the right side of the chassis. We also found a lot of free space over there, which made adding a heatsink (**at right**) much easier. The resulting heatsink became simply a rectangular piece of aluminum, bolted to the existing heatsink.



Make the heatsink from 1.5" aluminum bar stock, 1/8" thick –available at home improvement stores. Dimensions are given **below**. Mask and paint as shown **at right**, keeping the contact area clear. Drill and bolt to the existing heatsink using 4-40x1/2" screws. Use heatsink grease. Both of the CDP-200 heatsinks appear in the photo at **lower right**.

