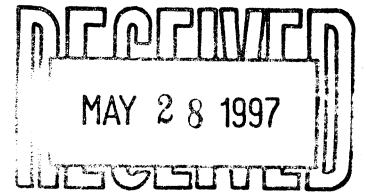
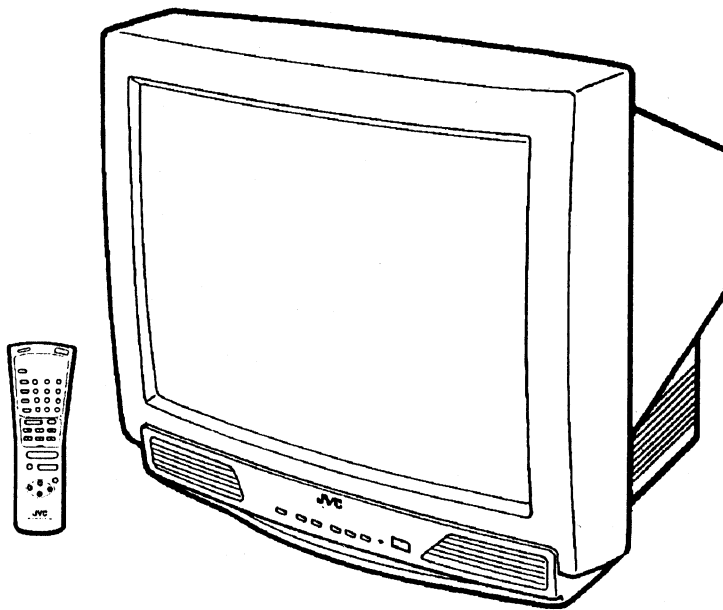

JVC**SERVICE MANUAL****COLOR TELEVISION****AV-27820** (US&CA)

BASIC CHASSIS

FA**CONTENTS**

■ SPECIFICATIONS	2
■ SAFETY PRECAUTIONS	3
■ FEATURES	4
■ DIFFERENCE LIST OF MAIN PARTS	4
■ OPERATING INSTRUCTIONS	5
■ SPECIFIC SERVICE INSTRUCTIONS	6
■ SERVICE ADJUSTMENTS	11
★ STANDARD CIRCUIT DIAGRAM (APPENDED)	2-1~2-16
■ PARTS LIST	23

AV-27820_(US&CA) STANDARD CIRCUIT DIAGRAM

NOTE ON USING CIRCUIT DIAGRAMS

1. SAFETY

The components identified by the  symbol and shading are critical for safety. For continued safety replace safety critical components only with manufactures recommended parts.

2. SPECIFIED VOLTAGE AND WAVEFORM VALUES

The voltage and waveform values have been measured under the following conditions.

- | | |
|---|--|
| (1) Input signal | : Color bar signal |
| (2) Setting positions of each knob/button and variable resistor | : Original setting position when shipped |
| (3) Internal resistance of tester | : DC 20k Ω /V |
| (4) Oscilloscope sweeping time | : H \Rightarrow 20 μ S/div
: V \Rightarrow 5mS/div
: Others \Rightarrow Sweeping time is specified |
| (5) Voltage values | : All DC voltage values |
- * Since the voltage values of signal circuit vary to some extent according to adjustments, use them as reference values.

3. INDICATION OF PARTS SYMBOL [EXAMPLE]

- In the PW board : R1209 \rightarrow R209

4. INDICATIONS ON THE CIRCUIT DIAGRAM

(1) Resistors

• Resistance value

- | | |
|---------|-----------------|
| No unit | : [Ω] |
| K | : [K Ω] |
| M | : [M Ω] |

• Rated allowable power

- | | |
|---------------|----------------|
| No indication | : 1/6[W] |
| Others | : As specified |

• Type

- | | |
|---------------|-----------------------------|
| No indication | : Carbon resistor |
| OMR | : Oxide metal film resistor |
| MFR | : Metal film resistor |
| MPR | : Metal plate resistor |
| UNFR | : Uninflammable resistor |
| FR | : Fusible resistor |

* Composition resistor 1/2 [W] is specified as 1/2S or Comp.

(2) Capacitors

• Capacitance value

- | | |
|-------------|--------------|
| 1 or higher | : [pF] |
| less than 1 | : [μ F] |

• Withstand voltage

- | | |
|---------------|---------------------------|
| No indication | : DC50[V] |
| Others | : DC withstand voltage[V] |
| AC indicated | : AC withstand voltage[V] |

* Electrolytic Capacitors

- | | |
|----------------|--|
| 47/50[Example] | : Capacitance value[μ F]/withstand voltage[V] |
|----------------|--|



• Type

- | | |
|---------------|-------------------------------------|
| No indication | : Ceramic capacitor |
| MY | : Mylar capacitor |
| MM | : Metalized mylar capacitor |
| PP | : Polypropylene capacitor |
| MPP | : Metalized polypropylene capacitor |
| MF | : Metalized film capacitor |
| TF | : Thin film capacitor |
| BP | : Bipolar electrolytic capacitor |
| TAN | : Tantalum capacitor |

(3) Coils

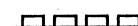

- | | |
|---------|----------------|
| No unit | : [μ H] |
| Others | : As specified |

(4) Power Supply



- | | |
|--|--------------|
|  | : B1(129.5V) |
|  | : B2(12V) |
|  | : 9V |
|  | : 5V |

* Respective voltage values are indicated.





(5) Test Point

- | | |
|---|---------------------------|
|  | : Test point |
|  | : Only test point display |



(6) Connecting method

- | | |
|---|-------------------------|
|  | : Connector |
|  | : Wrapping or soldering |
|  | : Receptacle |

(7) Ground symbol

- | | |
|---|---------------------------------|
|  | : LIVE side ground |
|  | : ISOLATED(NEUTRAL) side ground |
|  | : EARTH ground |
|  | : DIGITAL ground |

5. NOTE FOR REPAIRING SERVICE

This model's power circuit is partly different in the GND. The difference of the GND is shown by the LIVE : () side GND and the ISOLATED(NEUTRAL) : () side GND. Therefore, care must be taken for the following points.

- Do not touch the LIVE side GND or the LIVE side GND and the ISOLATED(NEUTRAL) side GND simultaneously. If the above caution is not respected, an electric shock may be caused. Therefore, make sure that the power cord is surely removed from the receptacle when, for example, the chassis is pulled out.
- Do not short between the LIVE side GND and ISOLATED(NEUTRAL) side GND or never measure with a measuring apparatus (oscilloscope, etc.) the LIVE side GND and ISOLATED(NEUTRAL) side GND at the same time. If the above precaution is not respected, a fuse or any parts will be broken.

◇ Since the circuit diagram is a standard one, the circuit and circuit constants may be subject to change for improvement without any notice.

CIRCUIT DIAGRAMS AND PWB PATTERNS

This

MAIN PWB, CRT SOCKET PWB, FRONT CONTROL PWB CIRCUIT DIAGRAMS

- NOTE**
- *1 : CHIP PNP Tr 2SA1037K(QR)-X BW : BUS WIRE
 - *2 : CHIP NPN Tr 2SC2412K(QR)-X OPT : NON-MOUNT (OPEN)
 - *3 : CHIP PNP D-Tr DT1A124KA-X O : 0Ω RESISTOR
 - *4 : CHIP NPN D-Tr DTC124KA-X
 - *5 : Si DIODE 1S5133-T
 - *6 : ZENER DIODE MTZJ5.11C1-T2
 - *7 : ZENER DIODE MTZJ5.61A1-T2
 - *8 : CHIP PNP D-Tr DT1A124SA-T

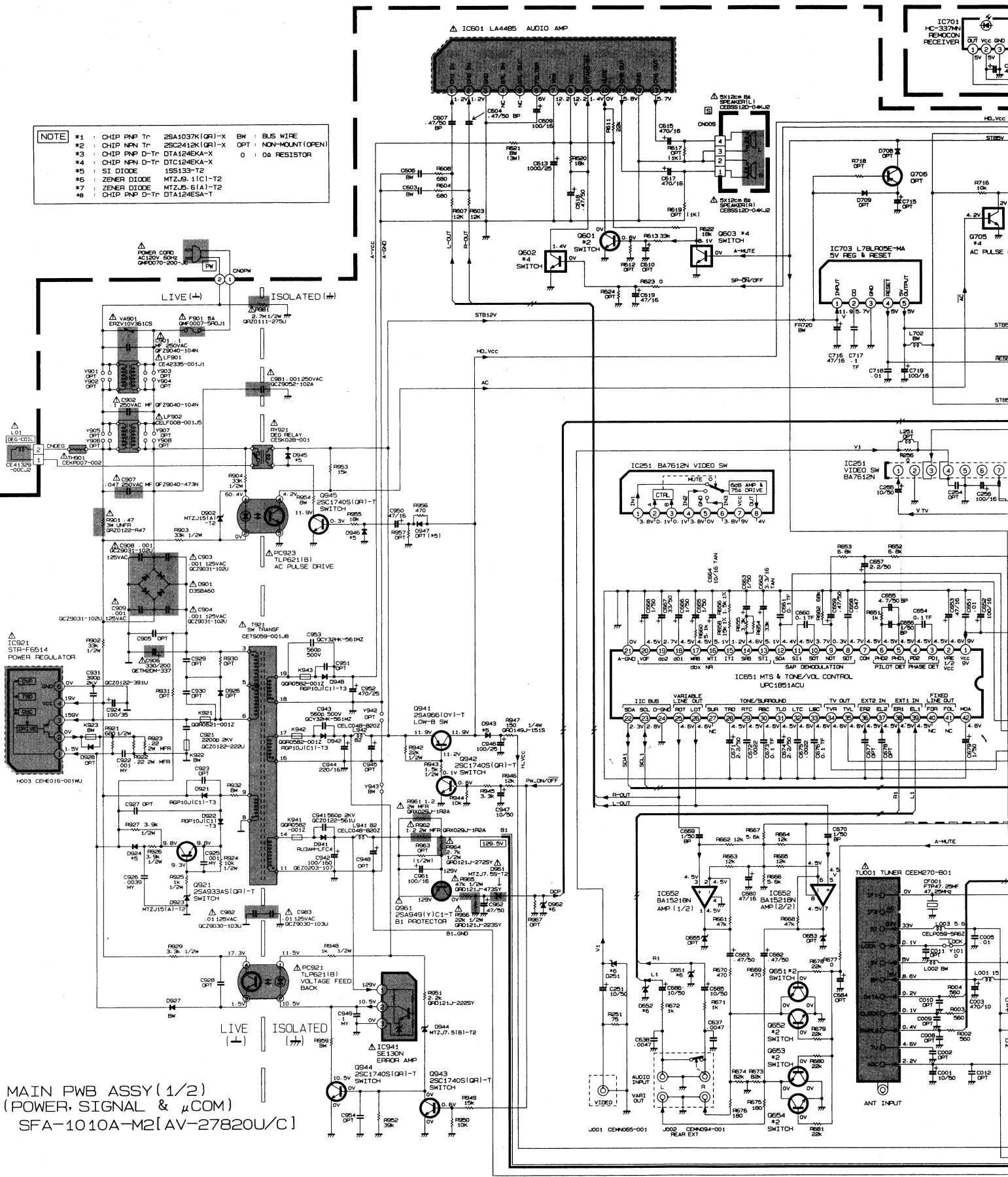

MAIN PWB ASSY (1/2)
 (POWER, SIGNAL & μCOM)
 SFA-1010A-M2(AV-27820U/C)

This schematic diagram is applicable to both (US) and (CA) models.

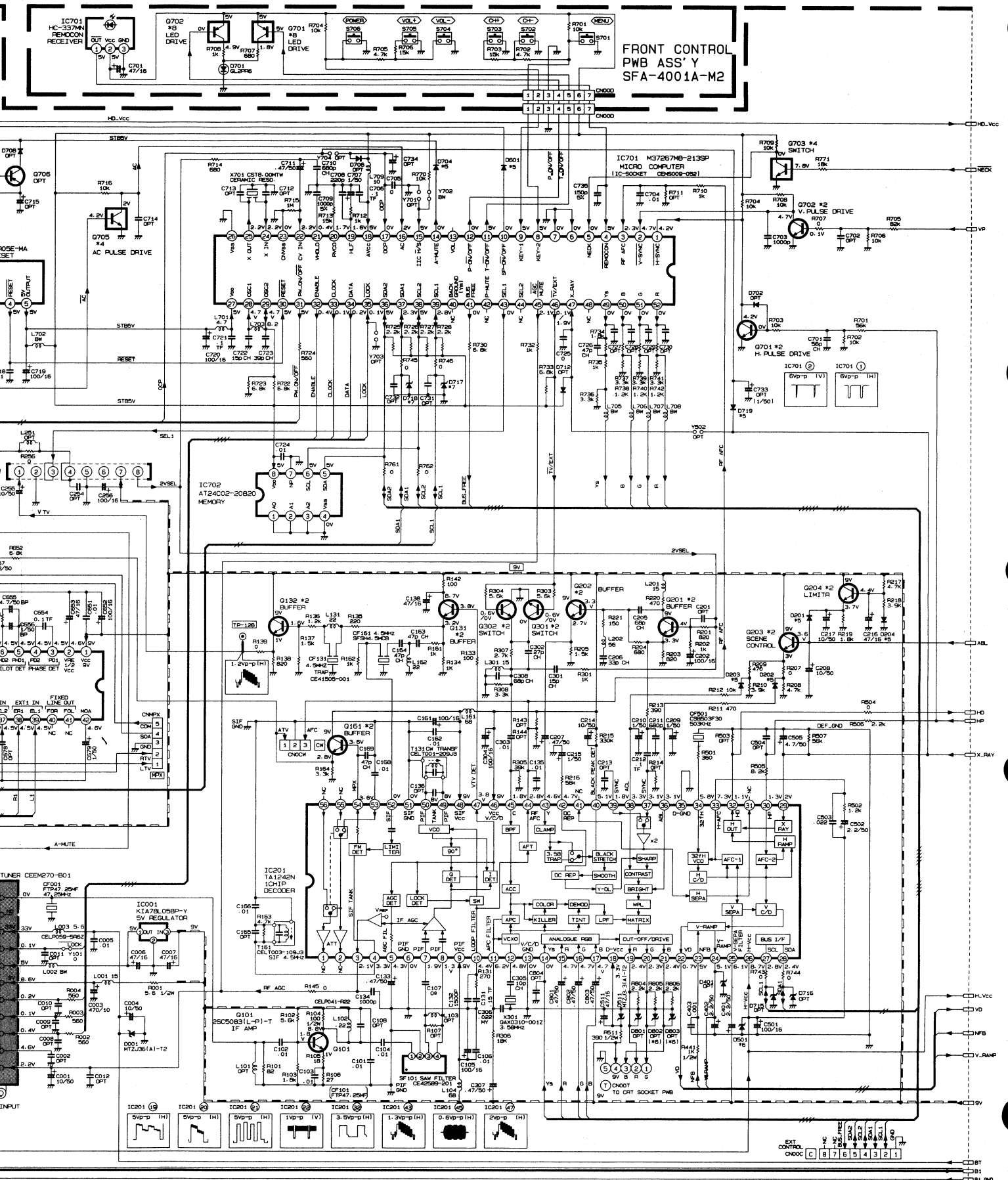

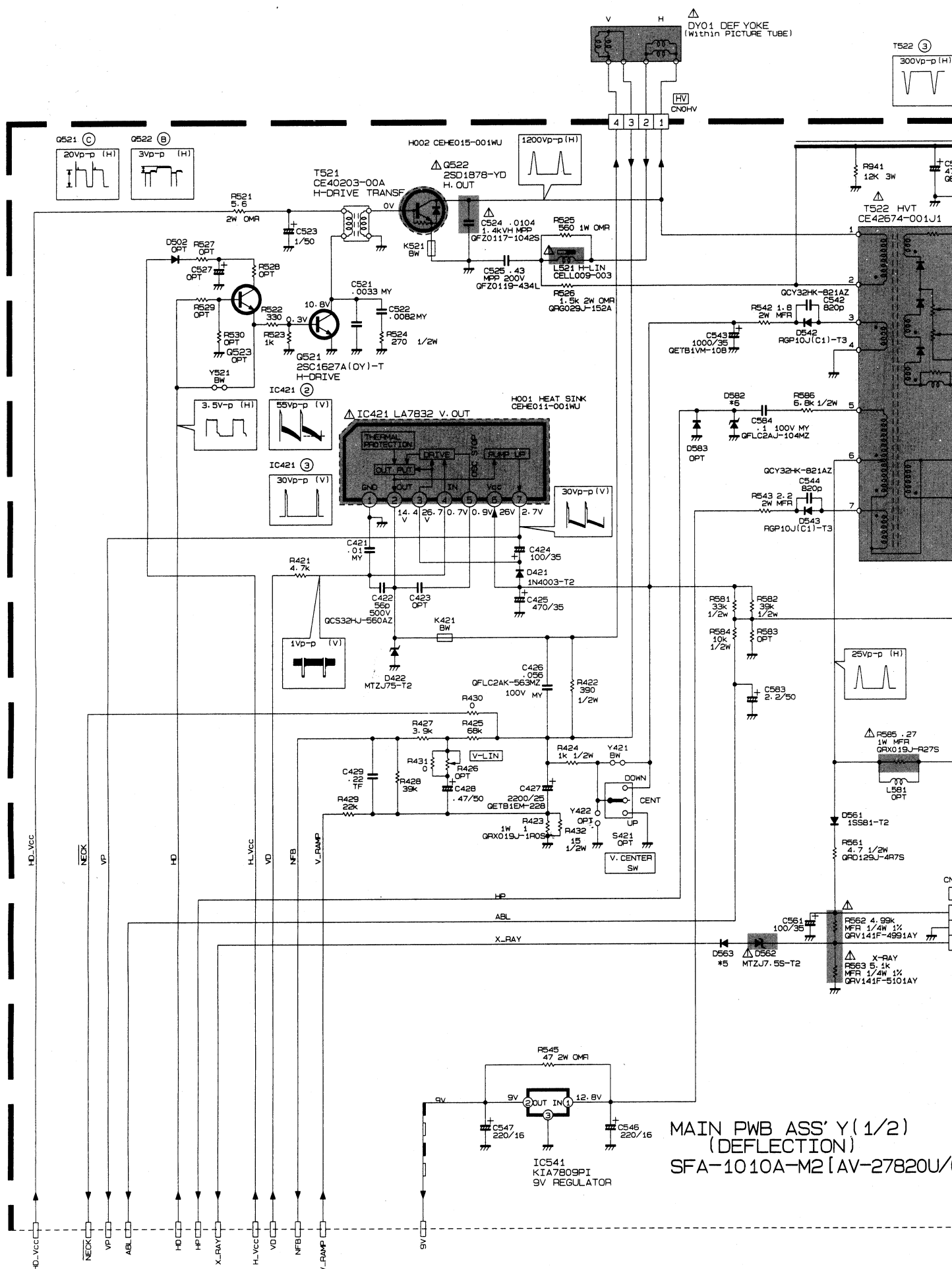
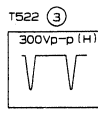

MAIN PWB ASS'Y (1/2)
(DEFLECTION)
SFA-1010A-M2 [AV-27820U/C

Refer to the following PW Board pattern : MAIN PWB PATTERN Page 2-13~2-14,
FRONT CONTROL PWB PATTERN Page 2-15,
CRT SOCKET PWB PATTERN Page 2-15.

(BE)

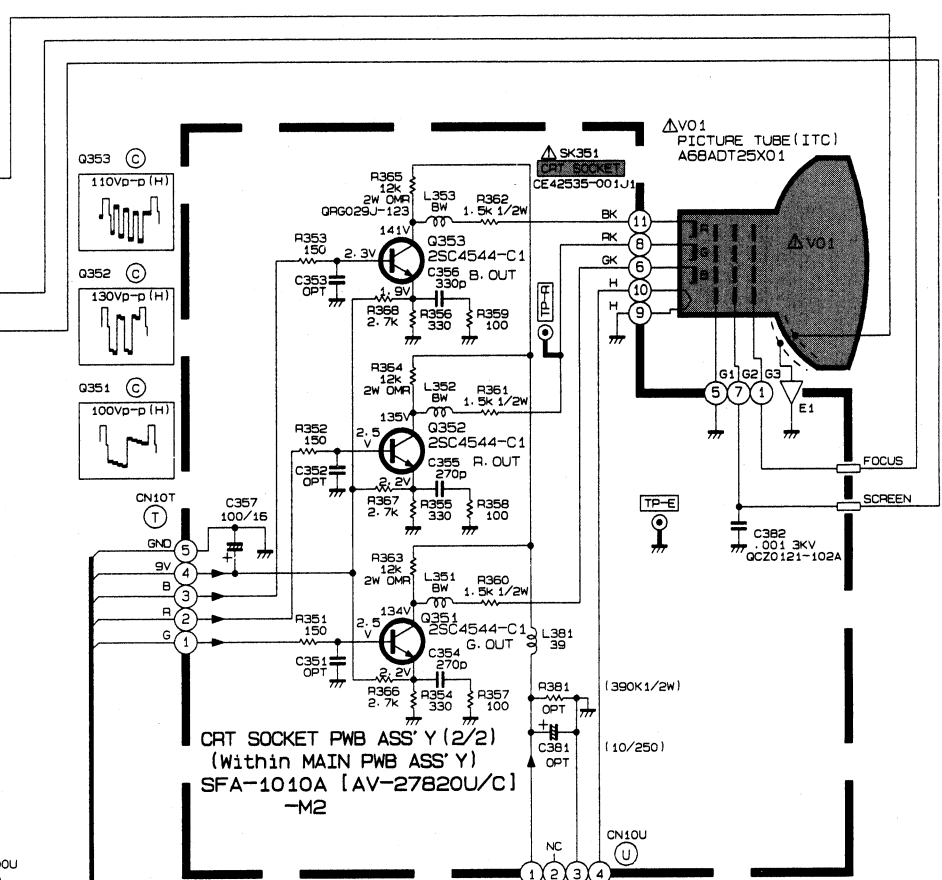
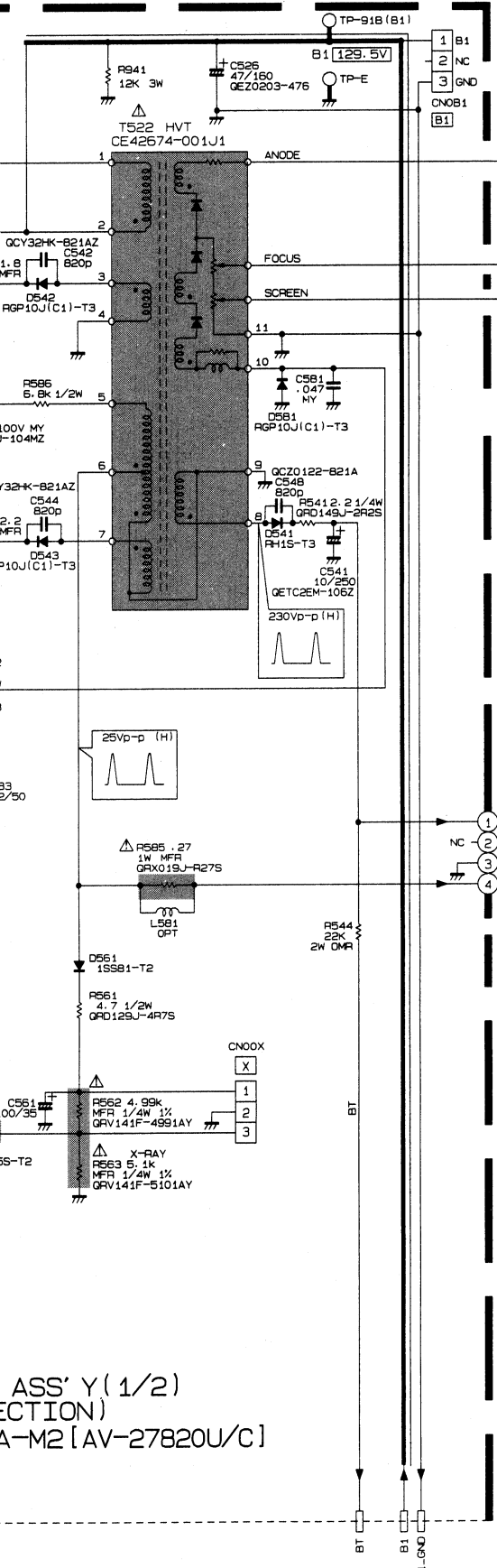
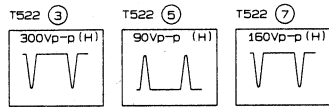

NOTE

*1	: CHIP PNP TR	2SA1037K9QR1-X
*2	: CHIP NPN TR	2SC2412K(QR)1-X
*3	: CHIP PNP D-TR	DTA124EKA-X
*4	: CHIP NPN D-TR	DTC124EKA-X
*5	: SI DIODE	1SS133-T2
*6	: ZENER DIODE	MTZJ9.1(C)-T2
BW	: BUS WIRE	
OPT	: NON-MOUNT (OPEN)	
0	: 0Ω RESISTOR	