

# SHARP SERVICE MANUAL

S35M113G-M60/

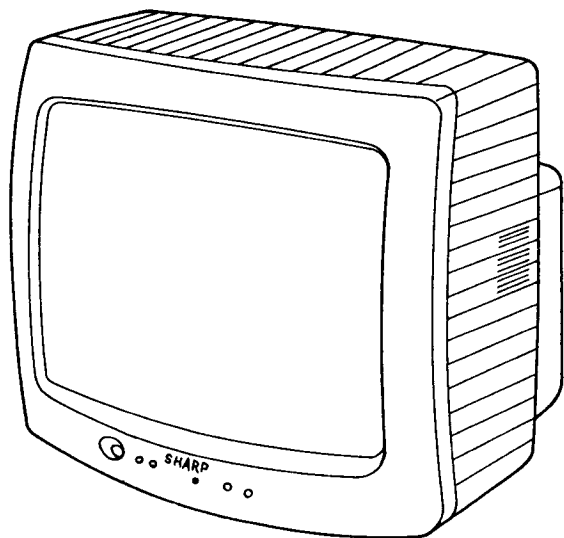

## COLOR TELEVISION

Chassis No. SN-50

# MODEL 13G-M60

In the interests of user-safety (Required by safety regulations in some countries ) the set should be restored to its original condition and only parts identical to those specified should be used.

## CONTENTS

	Page
• IMPORTANT SERVICE SAFETY PRECAUTION .....	2
• ELECTRICAL SPECIFICATIONS .....	3
• LOCATION OF USER'S CONTROL .....	4
• INSTALLATION AND SERVICE INSTRUCTIONS .....	5
• CHASSIS LAYOUT .....	11
• BLOCK DIAGRAM .....	12
• PRINTED WIRING BOARD ASSEMBLIES .....	15
• SCHEMATIC DIAGRAM .....	17
• REPLACEMENT PARTS LIST .....	20
• PACKING OF THE SET .....	27

# INSTALLATION AND SERVICE INSTRUCTIONS

- Note:** (1) When performing any adjustments to resistor controls and transformers use non-metallic screwdriver or TV alignment tools.  
 (2) Before performing adjustment, TV set must be on at least 15 minutes.

## CIRCUIT PROTECTION

The receiver is protected by a 4.0A fuse (F701), mounted on PWB-A, wired into one side of the AC line input.

## + 120V DC REGULATOR

### ADJUST-MENT

The +120V DC Adj. control (R706) is adjusted at the factory. However, should readjustment be required, proceed as follows:

1. Actuate the receiver with 120V AC input voltage.
2. Select a local channel.
3. Connect positive lead of Digital Voltmeter to C712(positive side) on PWB-A; negative lead to chassis ground.
4. Adjust R706 to obtain a +119V DC reading.

**CAUTION:** The reading should be within +119V  $\pm$  1VDC to ensure normal function and circuitry reliability.

## X-RADIATION PROTECTOR CIRCUIT TEST

1. After service has been performed on the horizontal deflection system, high voltage system, or +B system, test the X-Radiation protection circuit to ascertain proper operation as follows:

- 1) Apply 120V AC using a variac transformer for accurate input voltage.
- 2) Allow for warm up and adjust all customer controls for normal picture and sound.
- 3) Check the voltage of test point TP654. (It's voltage should be about 19.7V DC.)
- 4) Apply external 25V DC at TP654 by using an external DC supply, The increased voltage will cause the TV to shut off.
- 5) Turn on the power again. Unplug the AC power cord, wait 5 seconds, and plug the AC power cord in the outlet again.

Next turn on the power and make sure the image is normal on the screen.

- 6) If the TV dose not shut off in step 4, the circuit must be repaired before the set is returned to the customer.
2. When the IC2001 or IC2702 has been replaced, recheck the X-ray protector in the following steps.
  - 1) Select a local channel.

- 2) Connect a digital voltmeter to TP654 and make sure that the voltmeter reads  $19.7 \pm 1.5V$ .
- 3) Enter the service mode and select service adjustment "S32".
- 4) Push the CH-UP or CH-DOWN key on the remote control and make sure the data changes. (SPEC D33-40)
- 5) Now take the steps 4, 5 and 6 in the X-radiation protector circuit test.

## HIGH VOLTAGE CHECK

High voltage is not adjustable but must be checked to verify that the receiver is operating within safe and efficient design limitations as specified checks should be as follows:

1. Connect an accurate high voltage meter between ground and anode.
2. Operate receiver for at least 15 minutes at 120V AC line voltage, with strong air signal or properly tuned in test signal.
3. Set Service mode on, service No. S19 and Bus data D1 (Y-mute on).
4. The voltage should be approximately 23.5kV (at zero beam).  
If a correct reading cannot be obtained, check circuitry for malfunctioning components. After the voltage test, make Y-mute off (normal mode).

## CONNECTING NOTICE

1. The following connecting cords of this model do not have any symbols which identify the connection points on the PWB.  
In servicing this model, Instead the wires of these cords are color-coded as shown in Table 1.

PARTS CODE	SYMBOL ON PWB	PIN NO./WIRE COLOR				
		1	2	3	4	5
QCNW-1769PEZZ	GC	GREEN	BROWN	WHITE	WHITE	WHITE
QCNW-1768PEZZ	YC	YELLOW	BROWN	WHITE	WHITE	-

Table-1

The F-series SHARP TVS have most of the analog setup adjustments eliminated. Coil and variable resistor adjustments are now performed digitally by using the remote transmitter or set's volume and channel change function buttons.

Note: There are still a few analog adjustments in the F-series such as 120V adjust, focus, master screen voltage and coils in the picture if/detector circuit.

Follow the steps below whenever service adjustment is required. See table "B" to determine if service adjustments are required.

### 1. Service mode -

Before putting unit into the service mode, check, that customer adjustments are in the normal mode. use the reset function in the video adjust menu to ensure customer controls are in their proper ( reset ) position.

### To enter the service mode -

Momentarily short TP2001 to TP2002 ( see figure A ).

CAUTION: During the adjustment, keep TP2001 and TP2002 short-circuited. Re aware TP2001 to TP2002, be aware that as these test points are shorted they toggle between service and normal. when successfully entered, the service mode will be displayed as shown in figure "B". The "S" figure ( in the left hand bottom corner ) stands for service adjustment and the number following "S" is the service adjustment number ( see figure "B" ). in the right hand bottom corner is the letter " D " which stands for data, followed by a number which is the digital value of the adjustment.

### To exit service mode-

Turn off the power or unplug the set.

### 2. Service number selection

Once in the service mode, press the channel up or channel down button on the remote transmitter or at the set. the "S" number ( service adjustment number ) will vary in increments of one, from 1 to 25 ( table "A" ) . Select the item you wish to adjust.

### 3. Data number selection

Press the volume up or down button to adjust the data number in the lower right hand side of the screen.

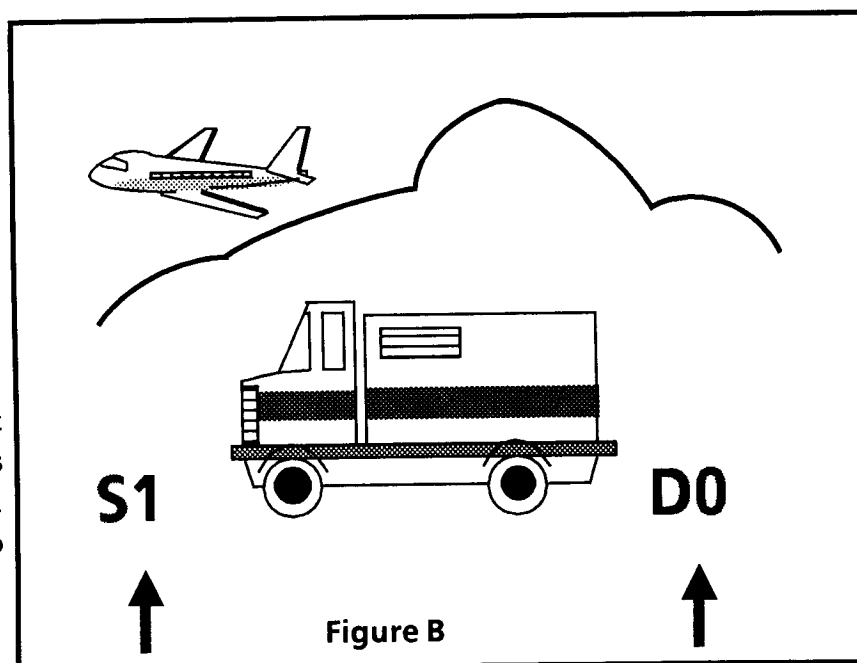
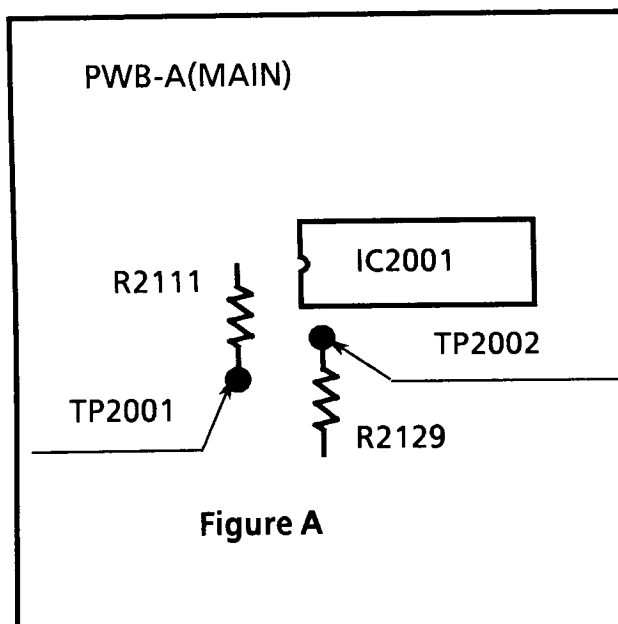

SERVICE NUMBER	ADJUSTMENT ITEM	DATA		ADJUSTMENT COMMENTS
		INITIAL VALUE	RANGE	
S1	SUB-PICTURE	85	0-127	Must be set to "0" "0" produces a no picture symptom-black raster.  "0" = ON, "1" = OFF "0" = Bandpass, "1" = Take off "0" = Normal, "1" = NO Blanking "0" = Normal raster, "1" = no "Y" "2" = Test mode, "3" = NO Vertical "0" = x2 gain, "1" = normal gain  "0" = Normal viewing "1" = not available
S2	SUB-TINT	70	0-127	
S3	SUB-COLOR	50	0-127	
S4	SUB-BRIGHTNESS	64	0-127	
S5	SHARPNESS	36	0-63	
S6	VERTICAL PHASE	0	0-7	
S7	HORIZONTAL POSITION	18	0-31	
S8	RF-AGC	35	0-63	
S9	VERTICAL SIZE	32	0-63	
S10	VCO	60	0-127	
S11	R CUT-OFF	0	0-255	
S12	G CUT -OFF	0	0-255	
S13	B CUT-OFF	0	0-255	
S14	G GAIN	127	0-255	
S15	B GAIN	127	0-255	
S16	TRAP(3.58MHz)	0	0-1	
*S17	BPF	1	0-1	
*S18	BLANKING	0	0-1	
S19	Y-MUTE/VERT,COLLAPSE	0	0-3	
*S20	HORZ.AFC	1	0-1	
S21	WHITE PEAK LIMITER	1	0-1	
*S22	60Hz	0	0-1	
S25	CAPTION POSITION	23	0-15	
S32	X-RAY PROTECTOR	36	33-40	

\*No adjustment is required due to proper setting being made by IC2001 automatically.

Table - A

PART REPLACED	ADJUSTMENT		NOTES
	NECESSARY	UNNECESSARY	
IC2001		X	Data is stored in IC2702.
IC201	X		The adjustment is needed to compensate for characteristics of parts including IC201.
IC2702	X		Initial setting values are written from IC2001. Adjust for best results.
CRT	X		Adjust items related to picture tube only.

Table - B

## ■ Service adjustment

### VCO Adjustment

1. Connect a digital voltmeter between pin 44 of IC201 and ground.
2. Select a good local channel.
3. Enter the service mode. select adjustment "S10".
4. Adjust the data so that digital voltmeter should read 2.2V.
5. Adjustment is complete, remove the voltmeter, return to "normal" mode.

### RF AGC Adjustment

1. Have unit receive a good local channel.
2. Enter the service mode and select service adjustment "S8".
3. Set the data value to point where no noise or beat appears.
4. Select another channel to confirm that no noise or beat appears.

NOTE 1 : You will have to come out of the service mode to select another channel.

NOTE 2 : Setting the data to "0" will produce a black raster.

### Screen adjustment

1. Connect a digital voltmeter between TP852 and TP853 on the CRT socket PWB.

Note: These test points may not be provided.

Then connect the voltmeter to both ends of R852 located near Q852 on the foil side.

2. Select a good local channel.
3. Enter the service mode and select service adjustment "S3" and set the data value to "0" to set the color level to minimum. You may skip this step if you selected a B/W picture or monoscope pattern.
4. Select service adjustment "S19" and adjust the data value to "1" this turns off the luminance signal (Y-mute).
5. Select service adjustment "S4" and adjust data value to obtain 0.17volts on the digital voltmeter.

6. Adjust the master screen control until raster darkens to the point where raster is barely seen.
7. Adjust service adjustments "S11" red, "S12" green and "S13" blue to obtain a good grey scale with normal whites at low brightness level.
8. Select service adjustment "S19" and reset data to "0" Select service adjustment "S3" and reset data to obtain normal color level.
9. Remove digital voltmeter. reset master screen control to obtain normal brightness range.

### White balance adjustment

1. Have unit receive a good local channel.
2. Enter the service mode. select service adjustment "S3" and set to "0" ( minimum color) . "S3" does not have to be adjusted if you selected a B/W picture or monoscope pattern.
3. Alternately adjust service adjustment data of "S14" and "S15" until a good grey scale with normal whites is obtained.
4. Select service adjustment "S3" and adjust data to obtain normal color level.

### Sub-picture adjustment

1. Have unit receive a good local channel.
2. Make sure the customer picture control is set to maximum.
3. Enter the service mode and select service adjustment "S1".
4. Adjust the data value to achieve normal contrast range.

### Sub-Tint Adjustment

1. Have unit receive a good local channel.
2. Set customer tint control to center of its range.
3. Enter the service mode and select service adjustment "S2".
4. Adjust "S2" data value to obtain normal flesh tones.

### Sub-color adjustment

1. Have unit receive a good local channel.
2. Make sure the customer color control is set to center position.
3. Enter the service mode and select service adjustment "S3".
4. Adjust "S3" data value to obtain normal color level.

### Sub-brightness adjustment

1. Have unit receive a good local channel.
2. Make sure the customer brightness control is set to center position.
3. Enter the service mode and select service adjustment "S4".
4. Adjust "S4" data value to obtain normal brightness level.

### Vertical-size adjustment

1. Have unit receive a good local channel.
2. Enter the service mode and select service adjustment "S9".
3. While observing the top and bottom of the screen, adjust "S9" data value to proper vertical size and linearity.

### Vertical phase adjustment

1. Enter the service mode and select service adjustment "S6".
2. Adjust data value to "0".

Note: This must be set "0" when adjust another data retrace line will be appear.

### Horizontal position adjustment

1. Have unit receive a good local channel.
2. Enter the service mode and select service adjustment "S7".
3. Adjust "S7" data value so that picture is centered.

### Caption position adjustment (horizontal)

1. Have unit receive a good local channel.
2. Enter the service mode and select service adjustment "S25".
3. A black text box appears on the screen ( see figure C ).
4. Adjust "S25" data value so that text box is positioned in the center of the screen.

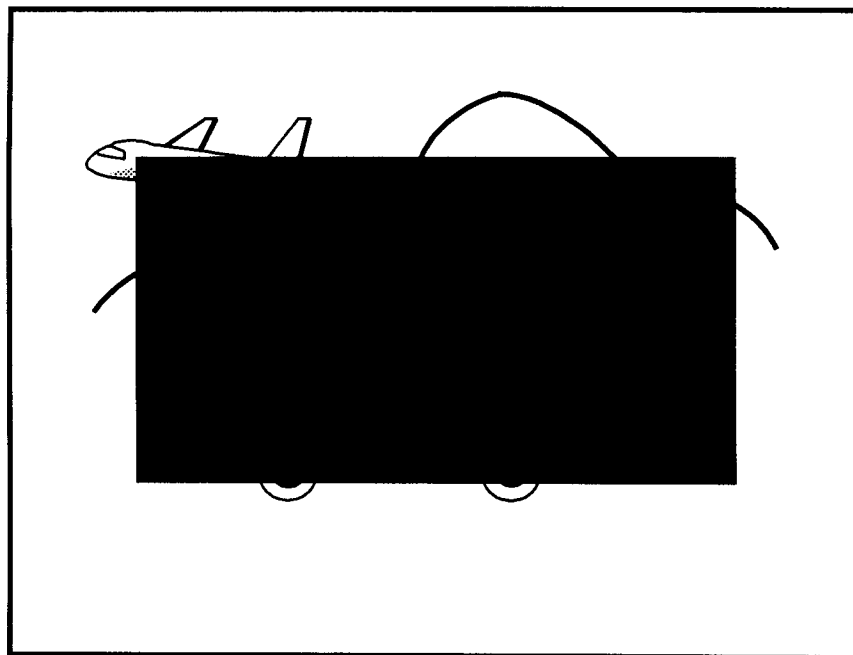

Figure-C.

### Horizontal AFC adjustment

1. Have unit receive a good local channel.
2. Enter service mode and select service adjustment "S20".
3. For normal viewing, adjust data value to "1" which is normal AFC gain.
4. If increased horizontal gain is required, adjust data value to "0" for two times normal gain.

### Blanking adjustment

1. Have unit receive a good local channel.
2. Enter the service mode and select service adjustment "S18".
3. This is a two position adjustment, "0" is normal blanking and "1" turns blanking OFF.
4. Adjust data value to "0" for normal viewing.

### White peak limiter (wpl) adjustment

1. Have unit receive a good local channel.
2. Enter the service mode and select service adjustment "S21".
3. This is a two position adjustment, "1" is ON, "0" is OFF.
4. Adjust data value to "1" for normal viewing.

### 3.58MHz trap adjustment

1. Have unit receive a good local channel.
2. Enter the service mode and select service adjustment "S16".
3. This is a two position adjustment, "0" is ON, "1" is OFF.
4. Adjust data value to "0" for normal viewing.

### Bandpass filter (BPF) adjustment

1. Have unit receive a good local channel.
2. Enter the service mode and select service adjustment "S17".
3. This is a two position adjustment, "0" is bandpass, "1" is OFF.
4. Adjust data value to "1" for normal viewing.

### Sharpness adjustments

1. Have unit receive a good local channel.
2. Enter the service mode and select "S5" for sharpness.
3. Adjust data value to "36" (center of data range) for sharpness adjustment.

### 60Hz adjustment

1. Have unit receive a good local channel.
2. Enter the service mode and select "S20".
3. The 60Hz adjustment is a two position, "0" is normal viewing, "1" is not used.
4. Adjust data value to "0".

NOTE: If data value is set to "1", you will have a "no sync" condition.

To exit the service mode, turn off power or unplug the set.

# BLOCK DIAGRAM

H  
G  
F  
E  
D  
C  
B  
A

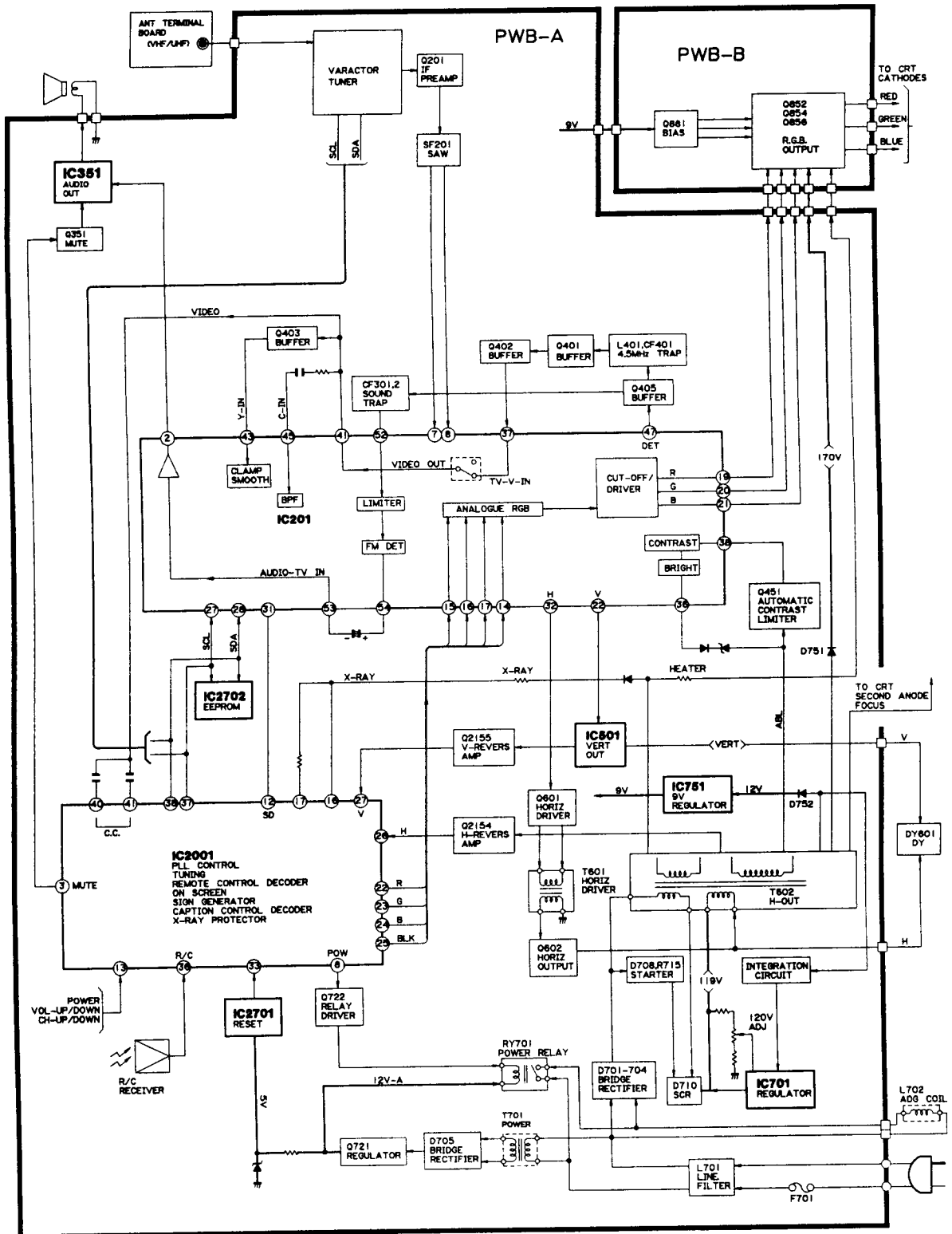

ANT TERMINAL BOARD (VHF/UHF)

VARACTOR TUNER

Q201 IF PREAMP

SF201 SAW

IC351 AUDIO OUT

Q351 MUTE

Q403 BUFFER

CF301.2 SOUND TRAP

Q402 BUFFER

Q401 BUFFER

L401, CF401 4.5MHz TRAP

Q405 BUFFER

IC201

CLAMP SMOOTH

BPF

LIMITER

FM DET

ANALOGUE RGB

CUT-OFF/DRIVER

R G B

CONTRAST

BRIGHT

Q451 AUTOMATIC CONTRAST LIMITER

D751 X

IC2702 EEPROM

X-RAY

X-RAY

HEATER

IC2001 PLL CONTROL TUNING REMOTE CONTROL DECODER ON SCREEN SIGN GENERATOR CAPTION CONTROL DECODER X-RAY PROTECTOR

MUTE

R/C

POW

Q722 RELAY DRIVER

IC2701 RESET

R/C RECEIVER

Q2155 V-REVERS AMP

IC801 VERT OUT

Q2154 H-REVERS AMP

Q601 HORIZ DRIVER

IC781 9V REGULATOR

D752

T601 HORIZ DRIVER

T602 H-OUT

Q602 HORIZ OUTPUT

D708, R715 STARTER

INTEGRATION CIRCUIT

D701-704 BRIDGE RECTIFIER

D710 SCR

IC701 REGULATOR

120V ADJ

L701 LINE FILTER

F701

RY701 POWER RELAY

T701 POWER

Q721 REGULATOR

D705 BRIDGE RECTIFIER

L702 ADG COIL

TO CRT CATHODES

RED GREEN BLUE

R.G.B. OUTPUT

TO CRT SECOND ANODE FOCUS

DY601 DY

1 2 3 4 5 6



# LOCATION OF USER'S CONTROL

## FRONT PANEL

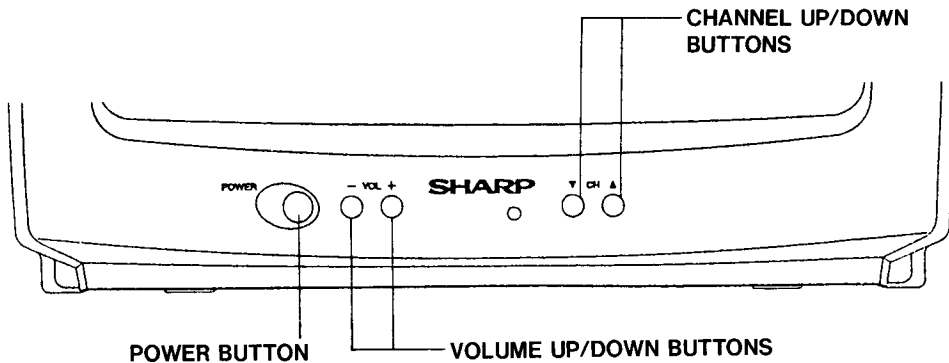

## BASIC REMOTE CONTROL FUNCTIONS

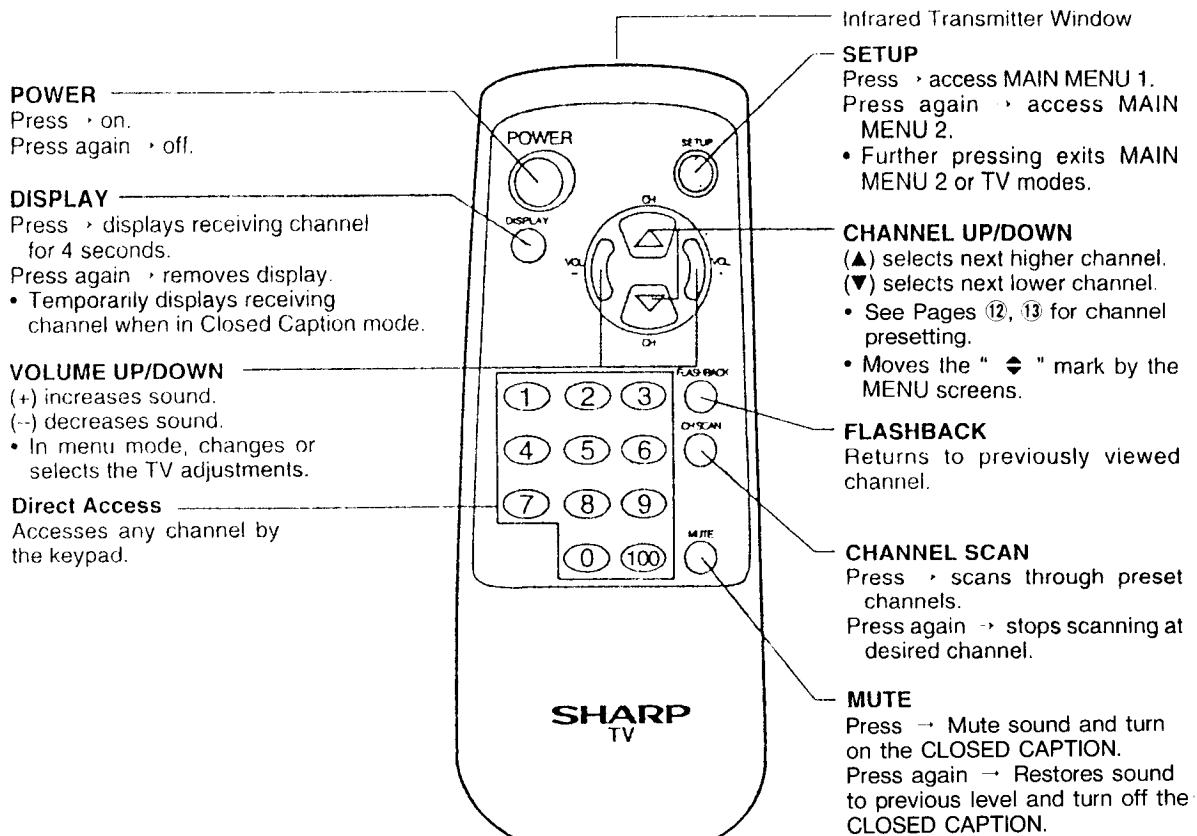

SCHEMATIC DIAGRAM: CRT

H

G

F

E

D

C

B

A

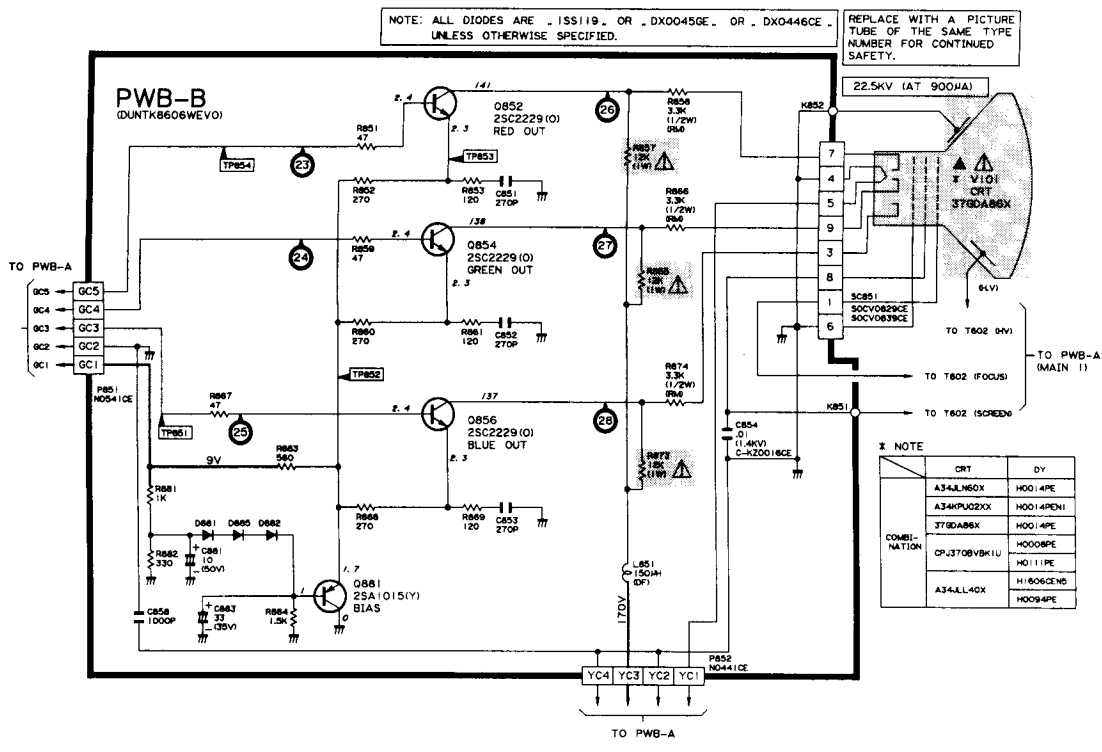

# CHASSIS LAYOUT

H  
G  
F  
E  
D  
C  
B  
A

1 2 3 4 5 6

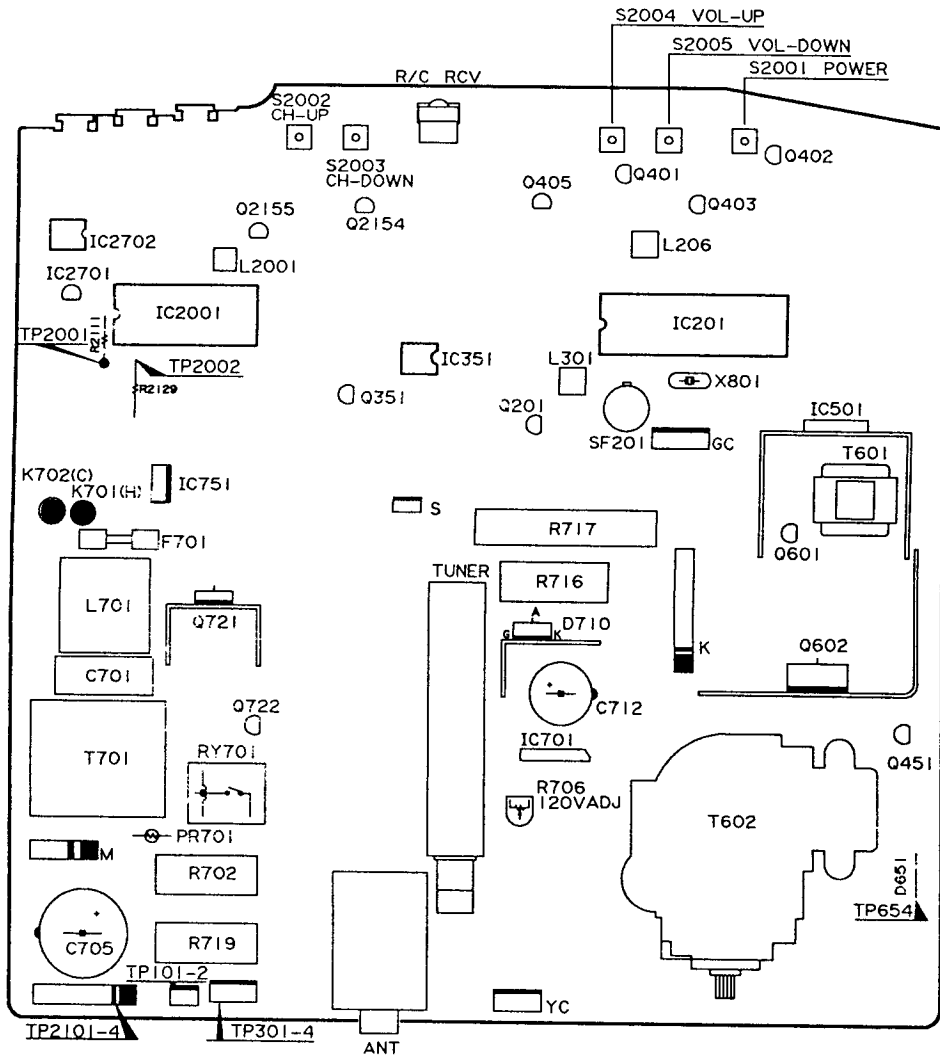
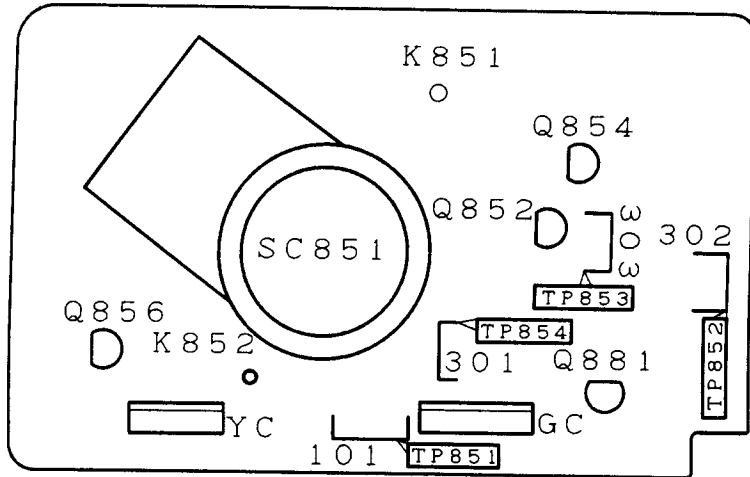

# REPLACEMENT PARTS LIST

**SAFETY NOTE** — Components marked with a (  $\Delta$  ) have special characteristics important to safety. Before replacing any of these components, read carefully the SAFETY NOTICE on page 3 of the Service Manual. Components marked with an (  $\blacktriangle$  ) are related to X-Ray Protection circuit.

**HOW TO ORDER REPLACEMENT PARTS** — To have your order filled promptly and correctly, please furnish the following information:  
 1. MODEL NO.                                      2. PART NO.                                      3. DESCRIPTION

Contact your nearest SHARP Parts Distributor to order.

For location of SHARP Parts Distributor, Please call Toll-Free; 1-800-BE-SHARP

★ MARK: SPARE PARTS-DELIVERY SECTION

Ref. No.	Part No.	★	Description	Code
<b>PICTURE TUBE</b>				
▲ $\Delta$ V101	VBA 3 4 JLN 6 0 X -S R		CRT	CB
	or		(DY601: H0014PE)	
	VB 34 KPU 02 X / * S R		CRT	
	or		(DY601: H0014PEN1)	
	VB 370 BVBK1U-S R		CRT	
	or		(DY601: H0008PE or H0111PE)	
	VB 34JLL40X/ * S R		CRT	BX
	or		(DY601: H0094PE or H1606CEN5)	
	VB 37 GDA 86 X /1E R		CRT	
			(DY601: H0014PE)	
▲ $\Delta$ DY601	RC i LH 0 0 1 4 PEZZ R		Deflection Yoke	BH
	or		(V101: A34JLN60X or 37GDA86X)	
	RC i LH 0 0 0 8 PEZZ R		Deflection Yoke	BB
	or		(V101: CPJ370BVBK1U)	
	RC i LH 0 0 1 4 PEN1 R		Deflection Yoke	
	or		(V101: 34PKPU02XX)	
	RC i LH 0 1 1 1 PEZZ R		Deflection Yoke	
	or		(V101: CPJ370BVBK1U)	
	RC i LH 1 6 0 6CEN5 R		Deflection Yoke	AZ
			(V101: A34JLL40X)	
	RC i LH 0 0 9 4 PEZZ R		Deflection Yoke	
			(V101: A34JLL40X)	
$\Delta$ L702	RC i L G 0 3 8 6 PEZZ R		Degaussing Coil	AK
	PMAGF3 0 0 6 CEZZ J		Magnet Ass'y	AK
			- Purity and Static Convergence	
	PSPA G 0 0 0 4 PEZZ R		Wedge (Gum), Yoke	AC
			Positioning (3 Used)	
	QEARC1404 PEZZ R		Grounding strap	AD
	MSPRT0001 PEFJ R		Spring for CRT	AC

## PRINTED WIRING BOARD ASSEMBLIES (NOT REPLACEMENT ITEM)

PWB-A	DUNTK8605WEV0	- Main P.W.B. UNIT	—
PWB-B	DUNTK8606WEV0	- CRT P.W.B. UNIT	—

Ref. No.	Part No.	★	Description	Code
<b>PWB-A DUNTK8605WEV0 MAIN UNIT</b>				
<b>TUNER</b>				
<b>NOTE: THE PARTS HERE SHOWN ARE SUPPLIED AS AN ASSEMBLY BUT NOT INDEPENDENTLY.</b>				
$\Delta$ TU101	VTUVTSH6UZ78/ J		Tuner	BF
<b>INTEGRATED CIRCUITS</b>				
$\Delta$ IC201	RH-iX2573CEZZ J		I.C.	
IC351	VHiTDA7233/-1 J		TDA7233	AF
$\Delta$ IC501	RH-iX1011CEZZ J		TA8403K	AG
▲ $\Delta$ IC701	RH-iX0137CEZZ J		T2508	AH
$\Delta$ IC751	VHiKA7809PI-1 J		KIA7809PI	AE
	or		VHiTA789S/-1	
▲ $\Delta$ IC2001	RH-iX2599CEZZ J		I.C.	BA
▲ $\Delta$ IC2701	VHiKIA7045P-1 J		KIA7045P	AD
▲ $\Delta$ IC2702	RH-iX2447CEN1 J		ST24C01CB1	AL
▲ $\Delta$ D710	VHSS6785GLB1E J		SI-Controlled Rectifier	AL
<b>TRANSISTORS</b>				
You can substitute for "VS2SC945AQ/-1" for "VS2SC2815YW-1"				
Q201	VS2SC1906//1E J		2SC1906	AC
Q351	VS2SC945AQ/-1 J		2SC945A(Q)	AB
Q402	VS2SC945AQ/-1 J		2SC945A(Q)	AB
Q405	VS2SC945AQ/-1 J		2SC945A(Q)	AB
Q451	VS2SC945AQ/-1 J		2SC945A(Q)	AB
▲ $\Delta$ Q722	VS2SC945AQ/-1 J		2SC945A(Q)	AB
Q2154	VS2SC945AQ/-1 J		2SC945A(Q)	AB
Q2155	VS2SC945AQ/-1 J		2SC945A(Q)	AB
Q401	VS2SA1015Y/1E J		2SA1015(Y)	AC
Q403	VS2SA1015Y/1E J		2SA1015(Y)	AC
Q601	VS2SC2482//1 J		2SC2482	AD
$\Delta$ Q602	VS2SD1554//1E J		2SD1554	AL
$\Delta$ Q721	VS2SC1983//1-2 J		2SC1983	AF

Ref. No.	Part No.	*	Description	Code	Ref. No.	Part No.	*	Description	Code
<b>DIODES</b>					<b>FILTER S</b>				
You can substitute for "RH-DX0446CEZZ" for "VHD1S5119//-1 and RH-DX0045GEZZ "					CF301	RFiLC0029TAZZ	J	Sound Take-off	AD
D101	RH-EX0701GEZZ	J	Zener Diode,32V	AB	CF302	RFiLC0267CEZZ	J	Sound Take-off	AD
D102	RH-EX0294CEZZ	J	Zener Diode,5.1V	AA	CF401	RFiLC0013CEZZ	J	4.5MHz	AE
D401	RH-EX0280CEZZ	J	Zener Diode,3V	AA	CF601	RFiLA0034CEZZ	J	503kHz	AD
D451	RH-EX0103CEZZ	J	Zener Diode,5.6V	AB	CF2101	RFiLC0121GEZZ	J	Filter	AD
D453	VHD1S5119//-1	J	1S5119	AB	SF201	RFiLC0137CEZZ	J	Surface Acoustic Wave Filter	AH
D454	VHD1S5119//-1	J	1S5119	AB	<b>COILS</b>				
D706	VHD1S5119//-1	J	1S5119	AB	L203	VP-XFR82K0000	J	0.82 $\mu$ H	AB
▲D709	VHD1S5119//-1	J	1S5119	AB	L204	VP-XFR68K0000	J	0.68 $\mu$ H	AB
D2102	VHD1S5119//-1	J	1S5119	AB	L206	RCiLi0588CEZZ	J	IF COIL	AF
D2103	VHD1S5119//-1	J	1S5119	AB	L207	VP-XF100K0000	J	10 $\mu$ H	AB
D2110	VHD1S5119//-1	J	1S5119	AB	L403	VP-XF100K0000	J	10 $\mu$ H	AB
D455	RH-EX0092CEZZ	J	Zener Diode,3.9V	AB	L301	RCiLi0605CEZZ	J	SIF Det	AE
D501	RH-DX0441CEZZ	J	Diode	AC	L401	VP-XF120K0000	J	12 $\mu$ H	AB
	or				L402	VP-XF3R3K0000	J	3.3 $\mu$ H	AB
	RH-DX0110CEZZ				L404	VP-XF8R2K0000	J	8.2 $\mu$ H	AB
▲D651	RH-DX0441CEZZ	J	Diode	AC	L405	VP-XF8R2K0000	J	8.2 $\mu$ H	AB
	or				L406	VP-XF680K0000	J	68 $\mu$ H	AB
	RH-DX0110CEZZ				L407	VP-XF680K0000	J	68 $\mu$ H	AB
▲D502	RH-DX0131CEZZ	J	Diode	AC	▲L701	RCiLF0254CEZZ	J	Line Filter	AG
▲D751	RH-DX0131CEZZ	J	Diode	AC		or			
D602	RH-EX0312CEZZ	J	Zener Diode,9.1V	AA		RCiLF0003PEZZ			
D605	RH-EX0312CEZZ	J	Zener Diode,9.1V	AA		or			
D2112	RH-EX0312CEZZ	J	Zener Diode,9.1V	AA		RCiLF0087CEZZ			
D653	RH-EX0313CEZZ	J	Zener Diode,9.1V	AA	L2001	RCiLB0131CEZZ	J	Oscillation Coil	AE
▲D701	RH-DX0154CEZZ	J	1S1887A	AC	<b>TRANSFORMERS</b>				
▲D702	RH-DX0154CEZZ	J	1S1887A	AC	T601	RTRNZ0073CEZZ	J	H-Drive	AF
▲D703	RH-DX0154CEZZ	J	1S1887A	AC	▲▲T602	RTRNF0057PEZZ	R	H-Output	BH
▲D704	RH-DX0154CEZZ	J	1S1887A	AC	▲T701	RTRNP0416CEZZ	J	Power	AV
D705	RH-DX0417CEZZ	J	Diode	AE	<b>CONTROL</b>				
	or				▲▲R706	RVR-M4328CEZZ	J	1k(B) 120V Adj.	AC
	RH-DX0200CEZZ				<b>PACKAGED CIRCUIT</b>				
▲D708	RH-EX0238CEZZ	J	Zener Diode,75V	AC	▲PR701	RMPTP0026CEZZ	J	Positive Coefficient Thermistor	AF
D721	RH-EX0019TAZZ	J	Zener Diode	AB	X801	RCRSB0001PEZZ	R	CRYSTAL,3.58MHz	AL
▲D752	RH-DX0226CEZZ	J	Diode	AC					
▲▲D2701	RH-EX0293CEZZ	J	Zener Diode,5.1V	AA					

Ref. No.	Part No.	*	Description	Code	Ref. No.	Part No.	*	Description	Code
<b>CAPACITORS</b>									
C101	VCEAGA1HW225M	J	2.2 50V EL.	AB	C401	VCKYMN1HB331K	J	330p 50V Ceramic	AA
C301	VCEAGA1HW225M	J	2.2 50V EL.	AB	C402	VCKYMN1HB101K	J	100p 50V Ceramic	AA
C502	VCEAGA1HW225M	J	2.2 50V EL.	AB	C2117	VCKYMN1HB101K	J	100p 50V Ceramic	AA
C516	VCEAGA1HW225M	J	2.2 50V EL.	AB	C2146	VCKYMN1HB101K	J	100p 50V Ceramic	AA
C2007	VCEAGA1HW225M	J	2.2 50V EL.	AB	C403	VCEAGA1HW105M	J	1.0 50V EL.	AC
C102	VCEAGA1CW477M	J	470 16V EL.	AC	C410	VCEAGA1HW105M	J	1.0 50V EL.	AC
C353	VCEAGA1CW477M	J	470 16V EL.	AC	C602	VCEAGA1HW105M	J	1.0 50V EL.	AC
C361	VCEAGA1CW477M	J	470 16V EL.	AC	C603	VCEAGA1HW105M	J	1.0 50V EL.	AC
C724	VCEAGA1CW477M	J	470 16V EL.	AC	C2701	VCEAGA1HW105M	J	1.0 50V EL.	AC
C752	VCEAGA1CW477M	J	470 16V EL.	AC	C404	VCEAGA1HW335M	J	3.3 50V EL.	AB
C103	VCEAGA1VW476M	J	47 35V EL.	AB	C405	VCEAGA1HW335M	J	3.3 50V EL.	AB
C365	VCEAGA1VW476M	J	47 35V EL.	AB	C413	VCEAGA1HW106M	J	10 50V EL.	AC
C721	VCEAGA1VW476M	J	47 35V EL.	AB	C715	VCEAGA1HW106M	J	10 50V EL.	AC
C104	VCKYPA1HF103Z	J	0.01 50V Ceramic	AA	C2704	VCEAGA1HW106M	J	10 50V EL.	AC
C306	VCKYPA1HF103Z	J	0.01 50V Ceramic	AA	C418	VCKYMN1HB151K	J	150p 50V Ceramic	AA
C422	VCKYPA1HF103Z	J	0.01 50V Ceramic	AA	C419	VCCSMN1HL330J	J	33p 50V Ceramic	AA
C2002	VCKYPA1HF103Z	J	0.01 50V Ceramic	AA	C420	VCCSPA1HL820J	J	82p 50V Ceramic	AA
C105	VCSATA1CE226K	J	22 16V Tantalum,AD		C421	VCCCMN1HH180J	J	18p 50V Ceramic	AA
C201	VCKYMN1HB102K	J	1000p 50V Ceramic	AA	C452	VCQYTA1HM563K	J	0.056 50V Mylar	AB
C205	VCKYMN1HB102K	J	1000p 50V Ceramic	AA	C2003	VCQYTA1HM563K	J	0.056 50V Mylar	AB
C206	VCKYMN1HB102K	J	1000p 50V Ceramic	AA	C2004	VCQYTA1HM563K	J	0.056 50V Mylar	AB
C305	VCKYMN1HB102K	J	1000p 50V Ceramic	AA	C501	VCSATA1CE225K	J	2.2 16V Tantalum	AB
C713	VCKYMN1HB102K	J	1000p 50V Ceramic	AA	C503	VCFYHA1HA274J	J	0.27 50V Mylar	AC
C204	VCKYMN1CY103N	J	0.01 16V Ceramic	AA	C504	VCKYPA2HB391K	J	390p 500V Ceramic	AA
C210	VCKYMN1CY103N	J	0.01 16V Ceramic	AA	C505	VCQYTA1HM473K	J	0.047 50V Mylar	AB
C213	VCKYMN1CY103N	J	0.01 16V Ceramic	AA	C507	VCQYTA1HM103K	J	0.01 50V Mylar	AB
C415	VCKYMN1CY103N	J	0.01 16V Ceramic	AA	C510	VCQYTA1HM103K	J	0.01 50V Mylar	AB
C416	VCKYMN1CY103N	J	0.01 16V Ceramic	AA	C601	VCQYTA1HM103K	J	0.01 50V Mylar	AB
C2005	VCKYMN1CY103N	J	0.01 16V Ceramic	AA	▲▲C714	VCQYTA1HM103K	J	0.01 50V Mylar	AB
C207	VCEAGA1HW474M	J	0.47 50V EL.	AA	C512	VCEACA1HC335M	J	3.3 50V EL.	AB
C211	VCEAGA1HW474M	J	0.47 50V EL.	AA	C513	VCEAGA1EW477M	J	470 25V EL.	AD
C802	VCEAGA1HW474M	J	0.47 50V EL.	AA	C514	VCEAGA1VW477M	J	470 35V EL.	AD
C209	VCEAGA1CW227M	J	220 16V EL.	AC	C710	VCEAGA1VW477M	J	470 35V EL.	AD
C214	VCEAGA1CW227M	J	220 16V EL.	AC	C515	VCKYPA2HB102K	J	1000p 500V Ceramic	AA
C212	VCKYMN1CX222M	J	2200p 16V Ceramic	AA	C651	VCKYPA2HB102K	J	1000p 500V Ceramic	AA
C302	VCQYTA1HM472K	J	4700p 50V Mylar	AB	C756	VCKYPA2HB102K	J	1000p 500V Ceramic	AA
C351	VCE9GA1HW225M	J	2.2 50V EL. (N.P)	AB	▲▲C605	RC-KZ0340CEZZ	J	820p 2kV Ceramic	AD
C352	VCEAGA1VW107M	J	100 35V EL.	AC		or			
C508	VCEAGA1VW107M	J	100 35V EL.	AC		RC-KZ0040CEZZ			
C2001	VCEAGA1VW107M	J	100 35V EL.	AC	▲▲C606	VCFPPD3CA682J	J	6800p 1600V Metalized Polypro Fil m	AE
C354	VCQYTA1HM104K	J	0.1 50V Mylar	AC	C608	VCFPPD2DB334J	J	0.33 200V Metalized Polypro Fil m	AF
C407	VCQYTA1HM104K	J	0.1 50V Mylar	AC	C609	VCKYPA2HB222K	J	2200p 500V Ceramic	AA
C412	VCQYTA1HM104K	J	0.1 50V Mylar	AC	C611	VCCSPA2HL180K	J	18p 500V Ceramic	AA
C355	VCEAGA1VW226M	J	22 35V EL.	AA	C652	VCEAGA1HW475M	J	4.7 50V EL.	AB
C453	VCEAGA1VW226M	J	22 35V EL.	AA	C2145	VCEAGA1HW475M	J	4.7 50V EL.	AB
C363	VCQYTA1HM682K	J	6800p 50V Mylar	AB					
C366	VCCSPA1HL330J	J	33p 50V Ceramic	AA					

Ref. No.	Part No.	*	Description	Code
△C701	RC-FZ0025CEZZ	J	0.47 AC125V Plastic AG	
	or			
	RC-QZ0055CEZZ			
	or			
	RC-FZ0045GEZZ			
C702	VCKYPB2HE103P	J	0.01 500V Ceramic AB	
C703	VCKYPB2HE103P	J	0.01 500V Ceramic AB	
C704	VCKYPB2HE103P	J	0.01 500V Ceramic AB	
△C705	RC-EZ0423CEZZ	J	620 200V EL. AP	
	or			
	RC-EZ0183CEZZ	J	620 200V EL.	
	or			
	RC-EZ0523CEZZ	J	560 200V EL.	
△C712	RC-EZ0378CEZZ	J	100 160V EL. AG	
C717	VCQPSB2DA473K	J	0.047 200V Polypro AB	
C718	VCKYPA2HB151K	J	150p 500V Ceramic AA	
C719	VCKYPA2HB332K	J	3300p 500V Ceramic AB	
C725	VCKYPA2HB152K	J	1500p 500V Ceramic AA	
C751	VCEAGA2EW106M	J	10 250V EL. AC	
C754	VCEAGA1CW337M	J	330 16V EL. AC	
C801	VCQYTA1HM223J	J	0.022 50V Mylar AA	
C803	VCCCMN1HH120J	J	12p 50V Ceramic AA	
C805	VCEAGA1HW104M	J	0.1 50V EL. AA	
C806	VCEAGA1HW104M	J	0.1 50V EL. AA	
C807	VCEAGA1HW104M	J	0.1 50V EL. AA	
C2109	VCKYMN1HB471K	J	470p 50V Ceramic AA	
C2110	VCKYMN1HB471K	J	470p 50V Ceramic AA	
C2111	VCKYMN1HB471K	J	470p 50V Ceramic AA	
C2112	VCKYMN1HB471K	J	470p 50V Ceramic AA	

## RESISTORS

RJ2	VRD-MN2BE000J	J	0 1/8W Carbon AA
RJ6	VRD-MN2BE000J	J	0 1/8W Carbon AA
RJ8	VRD-MN2BE000J	J	0 1/8W Carbon AA
RJ9	VRD-MN2BE000J	J	0 1/8W Carbon AA
RJ14	VRD-MN2BE000J	J	0 1/8W Carbon AA
RJ15	VRD-MN2BE000J	J	0 1/8W Carbon AA
RJ16	VRD-MN2BE000J	J	0 1/8W Carbon AA
RJ20	VRD-MN2BE000J	J	0 1/8W Carbon AA
RJ22	VRD-MN2BE000J	J	0 1/8W Carbon AA
RJ25	VRD-MN2BE000J	J	0 1/8W Carbon AA
RJ26	VRD-MN2BE000J	J	0 1/8W Carbon AA
RJ27	VRD-MN2BE000J	J	0 1/8W Carbon AA
RJ28	VRD-MN2BE000J	J	0 1/8W Carbon AA
RJ30	VRD-MN2BE000J	J	0 1/8W Carbon AA
RJ31	VRD-MN2BE000J	J	0 1/8W Carbon AA

Ref. No.	Part No.	*	Description	Code
RJ32	VRD-MN2BE000J	J	0 1/8W Carbon AA	
RJ33	VRD-MN2BE000J	J	0 1/8W Carbon AA	
RJ35	VRD-MN2BE000J	J	0 1/8W Carbon AA	
RJ36	VRD-MN2BE000J	J	0 1/8W Carbon AA	
R101	VRD-MN2BE103J	J	10k 1/8W Carbon AA	
△△R652	VRD-MN2BE103J	J	10k 1/8W Carbon AA	
R2008	VRD-MN2BE103J	J	10k 1/8W Carbon AA	
△△R2019	VRD-MN2BE103J	J	10k 1/8W Carbon AA	
R2127	VRD-MN2BE103J	J	10k 1/8W Carbon AA	
R2147	VRD-MN2BE103J	J	10k 1/8W Carbon AA	
R102	VRD-MN2BE1R0J	J	1.0 1/8W Carbon AA	
△R103	VRS-VV3DB151J	J	150 2W Metal Oxide AA	
△R104	VRS-VV3DB153J	J	15k 2W Metal Oxide AA	
R105	VRD-MN2BE823J	J	82k 1/8W Carbon AA	
R2003	VRD-MN2BE823J	J	82k 1/8W Carbon AA	
R2142	VRD-MN2BE823J	J	82k 1/8W Carbon AA	
R106	VRD-RA2BE121J	J	120 1/8W Carbon AA	
R107	VRD-RA2BE121J	J	120 1/8W Carbon AA	
R207	VRD-RA2BE121J	J	120 1/8W Carbon AA	
R901	VRD-RA2BE121J	J	120 1/8W Carbon AA	
R902	VRD-RA2BE121J	J	120 1/8W Carbon AA	
R201	VRD-MN2BE151J	J	150 1/8W Carbon AA	
R202	VRD-MN2BE122J	J	1.2k 1/8W Carbon AA	
R417	VRD-MN2BE122J	J	1.2k 1/8W Carbon AA	
R203	VRD-MN2BE682J	J	6.8k 1/8W Carbon AA	
R423	VRD-MN2BE682J	J	6.8k 1/8W Carbon AA	
R462	VRD-MN2BE682J	J	6.8k 1/8W Carbon AA	
R204	VRD-MN2BE470J	J	47 1/8W Carbon AA	
R206	VRD-MN2BE152J	J	1.5k 1/8W Carbon AA	
R418	VRD-MN2BE152J	J	1.5k 1/8W Carbon AA	
R453	VRD-MN2BE152J	J	1.5k 1/8W Carbon AA	
R208	VRD-MN2BE471J	J	470 1/8W Carbon AA	
R409	VRD-MN2BE471J	J	470 1/8W Carbon AA	
R504	VRD-MN2BE471J	J	470 1/8W Carbon AA	
R209	VRD-MN2BE331J	J	330 1/8W Carbon AA	
R401	VRD-MN2BE331J	J	330 1/8W Carbon AA	
R609	VRD-MN2BE331J	J	330 1/8W Carbon AA	
R2146	VRD-MN2BE331J	J	330 1/8W Carbon AA	
R303	VRD-MN2BE102J	J	1.0k 1/8W Carbon AA	
R407	VRD-MN2BE102J	J	1.0k 1/8W Carbon AA	
R408	VRD-MN2BE102J	J	1.0k 1/8W Carbon AA	
R416	VRD-MN2BE102J	J	1.0k 1/8W Carbon AA	
R2006	VRD-MN2BE102J	J	1.0k 1/8W Carbon AA	
R2007	VRD-MN2BE102J	J	1.0k 1/8W Carbon AA	
R2112	VRD-MN2BE102J	J	1.0k 1/8W Carbon AA	
R2113	VRD-MN2BE102J	J	1.0k 1/8W Carbon AA	
R2116	VRD-MN2BE102J	J	1.0k 1/8W Carbon AA	
R2125	VRD-MN2BE102J	J	1.0k 1/8W Carbon AA	

Ref. No.	Part No.	*	Description	Code	Ref. No.	Part No.	*	Description	Code
R2132	VRD-MN2BE102J	J	1.0k 1/8W Carbon	AA	R2703	VRD-MN2BE101J	J	100 1/8W Carbon	AA
R2133	VRD-MN2BE102J	J	1.0k 1/8W Carbon	AA	R506	VRD-RA2BE683G	J	68k 1/8W Carbon	AA
R2135	VRD-MN2BE102J	J	1.0k 1/8W Carbon	AA	R507	VRD-RA2BE104G	J	100k 1/8W Carbon	AA
▲▲ R2150	VRD-MN2BE102J	J	1.0k 1/8W Carbon	AA	R508	VRD-MN2BE473J	J	47k 1/8W Carbon	AA
R2152	VRD-MN2BE102J	J	1.0k 1/8W Carbon	AA	R2004	VRD-MN2BE473J	J	47k 1/8W Carbon	AA
R2201	VRD-MN2BE102J	J	1.0k 1/8W Carbon	AA	R2128	VRD-MN2BE473J	J	47k 1/8W Carbon	AA
R2202	VRD-MN2BE102J	J	1.0k 1/8W Carbon	AA	R511	VRD-RM2HD681J	J	680 1/2W Carbon	AA
R310	VRD-MN2BE153J	J	15k 1/8W Carbon	AA	R712	VRD-RM2HD681J	J	680 1/2W Carbon	AA
R351	VRD-MN2BE821J	J	820 1/8W Carbon	AA	R514	VRD-RM2HD1R5J	J	1.5 1/2W Carbon	AA
R352	VRD-MN2BE4R7J	J	4.7 1/8W Carbon	AA	▲ R515	VRN-SV2HB1R0J	J	1.0 1/2W Metal Film	AA
R355	VRD-MN2BE822J	J	8.2k 1/8W Carbon	AA	R516	VRD-RA2BE223G	J	22k 1/8W Carbon	AA
R357	VRD-RA2BE333J	J	33k 1/8W Carbon	AA	R517	VRD-RA2BE154J	J	150k 1/8W Carbon	AA
R703	VRD-RA2BE333J	J	33k 1/8W Carbon	AA	▲▲ R707	VRD-RA2BE154J	J	150k 1/8W Carbon	AA
R358	VRD-RA2BE152J	J	1.5k 1/8W Carbon	AA	R518	VRD-RA2BE123G	J	12k 1/8W Carbon	AA
R603	VRD-RA2BE152J	J	1.5k 1/8W Carbon	AA	R521	VRD-RA2BE273J	J	27k 1/8W Carbon	AA
R402	VRD-MN2BE391J	J	390 1/8W Carbon	AA	R524	VRD-MN2BE332J	J	3.3k 1/8W Carbon	AA
R604	VRD-MN2BE391J	J	390 1/8W Carbon	AA	R801	VRD-MN2BE332J	J	3.3k 1/8W Carbon	AA
R404	VRD-MN2BE330J	J	33 1/8W Carbon	AA	R2130	VRD-MN2BE332J	J	3.3k 1/8W Carbon	AA
R406	VRD-RA2BE680J	J	68 1/8W Carbon	AA	R525	VRD-RA2BE473J	J	47k 1/8W Carbon	AA
R410	VRD-MN2BE562J	J	5.6k 1/8W Carbon	AA	R607	VRD-RM2HD101J	J	100 1/2W Carbon	AA
R438	VRD-MN2BE562J	J	5.6k 1/8W Carbon	AA	R608	VRD-RA2BE471J	J	470 1/8W Carbon	AA
R459	VRD-MN2BE562J	J	5.6k 1/8W Carbon	AA	R610	VRD-RM2HD332J	J	3.3k 1/2W Carbon	AA
▲▲ R727	VRD-MN2BE562J	J	5.6k 1/8W Carbon	AA	▲ R611	VRS-SV3LB152J	J	1.5k 3.0W Metal Oxide	AB
R411	VRD-MN2BE563J	J	56k 1/8W Carbon	AA	▲ R612	VRN-VV3ABR22J	J	0.22 1W Metal Film	AA
R412	VRD-RA2BE391J	J	390 1/8W Carbon	AA	▲▲ R651	VRD-RM2HD1R0J	J	1.0 1/2W Carbon	AA
R413	VRD-MN2BE820J	J	82 1/8W Carbon	AA	▲ R655	VRS-VV3AB682J	J	6.8k 1W Metal Oxide	AA
R414	VRD-MN2BE820J	J	82 1/8W Carbon	AA	▲ R701	VRD-RM2HD824J	J	820k 1/2W Carbon	AA
R415	VRD-MN2BE820J	J	82 1/8W Carbon	AA	▲ R702	VRW-KQ3HC1R5K	J	1.5 5W Cement	AE
R419	VRD-MN2BE472J	J	4.7k 1/8W Carbon	AA	R704	VRD-RM2HD273J	J	27k 1/2W Carbon	AA
R439	VRD-MN2BE333J	J	33k 1/8W Carbon	AA	▲▲ R705	VRD-RA2EE104G	J	100k 1/4W Carbon	AA
R2143	VRD-MN2BE333J	J	33k 1/8W Carbon	AA	▲▲ R708	VRD-RA2EE562G	J	5.6k 1/4W Carbon	AA
R2701	VRD-MN2BE333J	J	33k 1/8W Carbon	AA	R709	VRD-MN2BE123J	J	12k 1/8W Carbon	AA
R440	VRD-RA2BE821J	J	820 1/8W Carbon	AA	R2002	VRD-MN2BE123J	J	12k 1/8W Carbon	AA
R657	VRD-RA2BE821J	J	820 1/8W Carbon	AA	R2140	VRD-MN2BE123J	J	12k 1/8W Carbon	AA
R441	VRD-MN2BE222J	J	2.2k 1/8W Carbon	AA	R2141	VRD-MN2BE123J	J	12k 1/8W Carbon	AA
R451	VRD-RA2BE472J	J	4.7k 1/8W Carbon	AA	R710	VRD-RA2EE123J	J	12k 1/4W Carbon	AA
R605	VRD-RA2BE472J	J	4.7k 1/8W Carbon	AA	R711	VRS-SV2HC470J	J	47 1/2W Metal Oxide	AA
▲ R452	VRC-MA2HG562K	J	5.6k 1/2W Solid	AA	▲ R713	VRD-RM2HD330J	J	33 1/2W Carbon	AA
▲ R454	VRS-SV2HC103J	J	10k 1/2W Metal Oxide	AA	▲ R715	VRS-SV2HC151J	J	150 1/2W Metal Oxide	AA
R455	VRD-RA2BE274J	J	270k 1/8W Carbon	AA	▲ R716	VRW-KQ3HC331K	J	330 5W Cement	AE
R456	VRD-RA2BE274J	J	270k 1/8W Carbon	AA	▲ R717	VRW-KQ4AC6R8K	J	6.8 10W Cement	AF
R457	VRD-MN2BE392J	J	3.9k 1/8W Carbon	AA	R721	VRD-RM2HD331J	J	330 1/2W Carbon	AA
R501	VRD-RA2BE102J	J	1.0k 1/8W Carbon	AA	▲ R729	VRS-VV3DB220J	J	22 2W Metal Oxide	AA
R505	VRD-MN2BE101J	J	100 1/8W Carbon	AA	▲ R751	VRS-VV3AB390J	J	39 1W Metal Oxide	AA
R2009	VRD-MN2BE101J	J	100 1/8W Carbon	AA	▲ R752	VRN-VV3AB1R8J	J	1.8 1W Metal Film	AA
R2011	VRD-MN2BE101J	J	100 1/8W Carbon	AA	▲ R754	VRN-RV3AB1R0J	J	1.0 1W Metal Film	AB
R2702	VRD-MN2BE101J	J	100 1/8W Carbon	AA	▲ R755	VRS-VV3AB470J	J	47 1W Metal Oxide	AA
					R2001	VRD-MN2BE683J	J	68k 1/8W Carbon	AA



Ref. No.	Part No.	*	Description	Code	Ref. No.	Part No.	*	Description	Code
R2005	VRD-MN2BE183J	J	18k 1/8W Carbon	AA	▲▲ RY701	RRLYU0022CEZZ	J	Relay,Power	AH
R2149	VRD-MN2BE183J	J	18k 1/8W Carbon	AA		or			
R2012	VRD-MN2BE272J	J	2.7k 1/8W Carbon	AA		RRLYU0031CEZZ			
R2013	VRD-RA2BE182J	J	1.8k 1/8W Carbon	AA	S2001	QSW-K0079GEZZ	J	Switch,Power	AB
R2014	VRD-MN2BE182J	J	1.8k 1/8W Carbon	AA	S2002	QSW-K0079GEZZ	J	Switch,CH-up	AB
R2015	VRD-MN2BE182J	J	1.8k 1/8W Carbon	AA	S2003	QSW-K0079GEZZ	J	Switch,CH-down	AB
R2018	VRD-RA2BE183J	J	18k 1/8W Carbon	AA	S2004	QSW-K0079GEZZ	J	Switch,VOL-up	AB
R2153	VRD-RA2BE183J	J	18k 1/8W Carbon	AA	S2005	QSW-K0079GEZZ	J	Switch,VOL-down	AB
R2111	VRD-RM2HD223J	J	22k 1/2W Carbon	AA	▲	RUNTK0476CEZZ	J	Antenna Box Unit	AS
R2129	VRD-RM2HD223J	J	22k 1/2W Carbon	AA					
R2115	VRD-MN2BE224J	J	220k 1/8W Carbon	AA					
R2118	VRD-RA2BE153J	J	15k 1/8W Carbon	AA					
R2119	VRD-RA2BE682J	J	6.8k 1/8W Carbon	AA					
R2120	VRD-RA2BE682J	J	6.8k 1/8W Carbon	AA					
R2121	VRD-RA2BE682J	J	6.8k 1/8W Carbon	AA					
R2122	VRD-RA2BE682J	J	6.8k 1/8W Carbon	AA					
▲▲ R2131	VRN-RA2BK223F	J	22k 1/8W Metal Film	AB					
▲▲ R2137	VRN-RA2BK473F	J	47k 1/8W Metal Film	AA					
▲▲ R2139	VRN-RA2BK823F	J	82k 1/8W Metal Film	AA					
R2154	VRD-RA2BE123J	J	12k 1/8W Carbon	AA					
R2155	VRD-RA2BE103J	J	10k 1/8W Carbon	AA					
R2156	VRD-RA2BE103J	J	10k 1/8W Carbon	AA					
▲ R2704	VRS-VV3AB331J	J	330 1W Metal Oxide	AA					
<b>PWB-B DUNTK8606WEV0 CRT UNIT</b>									
<b>TRANSISTORS</b>									
Q852	VS2SC2229O/1E	J	2SC2229(O)	AD					
Q854	VS2SC2229O/1E	J	2SC2229(O)	AD					
Q856	VS2SC2229O/1E	J	2SC2229(O)	AD					
Q881	VS2SA1015Y/1E	J	2SA1015(Y)	AC					
<b>DIODES</b>									
You can substitute for "RH-DX0446CEZZ" for "VHD1SS119//-1 and RH-DX0045GEZZ "									
D881	VHD1SS119//-1	J	1SS119	AB					
D882	VHD1SS119//-1	J	1SS119	AB					
D885	VHD1SS119//-1	J	1SS119	AB					
<b>COIL</b>									
L851	VP-DF151K0000	J	150μH	AB					
<b>CAPACITORS</b>									
C851	VCKYPA1HB271K	J	270p 50V Ceramic	AA					
C852	VCKYPA1HB271K	J	270p 50V Ceramic	AA					
C853	VCKYPA1HB271K	J	270p 50V Ceramic	AA					
C854	RC-KZ0016CEZZ	J	0.01 1.4kV Ceramic	AC					
C858	VCKYPA1HB102K	J	1000p 50V Ceramic	AA					
C883	VCEAGA1VW336M	J	33 35V EL.						
C881	VCEAGA1HW106M	J	10 50V EL.						
<b>RESISTORS</b>									
R851	VRD-RA2BE470J	J	47 1/8W Carbon	AA					
R859	VRD-RA2BE470J	J	47 1/8W Carbon	AA					
R867	VRD-RA2BE470J	J	47 1/8W Carbon	AA					
R852	VRD-RA2BE271J	J	270 1/8W Carbon	AA					
<b>MISCELLANEOUS PARTS</b>									
FB602	RBLN-0037CEZZ	J	Ferrite Bead	AB					
FB603	RBLN-0037CEZZ	J	Ferrite Bead	AB					
FB701	RBLN-0037CEZZ	J	Ferrite Bead	AB					
FB702	RBLN-0037CEZZ	J	Ferrite Bead	AB					
FB703	RBLN-0020CEZZ	J	Ferrite Bead	AB					
FH701	QFSHD1013CEZZ	J	Fuse Holder	AC					
	or								
	QFSHD1009CEZZ								
FH702	QFSHD1014CEZZ	J	Fuse Holder	AC					
	or								
	QFSHD1010CEZZ								
▲ F701	QFS-B4023CEZZ	J	Fuse,4A	AC					
	or								
	QFS-B4021GEZZ								
P101	QPLGN0241CE04	J	Plug,2pin	AA					
P351	QPLGN0241CEZZ	J	Plug,2pin	AA					
P601	QPLGN0505CEZZ	J	Plug,5pin	AB					
P701	QPLGN0207CEZZ	J	Plug,2pin	AA					
P751	QPLGN0441CEZZ	J	Plug,4pin	AB					
P2001	QPLGN0541CEZZ	J	Plug,5pin	AB					
P2101	QPLGN0404CEZZ	J	Plug,4pin	AB					
RMC2101	RRMCU0216CEZZ	J	Remote Receiver	AK					

Ref. No.	Part No.	*	Description	Code
R860	VRD-RA2BE271J	J	270 1/8W Carbon	AA
R868	VRD-RA2BE271J	J	270 1/8W Carbon	AA
R853	VRD-RA2BE121J	J	120 1/8W Carbon	AA
R861	VRD-RA2BE121J	J	120 1/8W Carbon	AA
R869	VRD-RA2BE121J	J	120 1/8W Carbon	AA
R857	VRS-VV3AB123J	J	12k 1W Metal Oxide	AA
R865	VRS-VV3AB123J	J	12k 1W Metal Oxide	AA
R873	VRS-VV3AB123J	J	12k 1W Metal Oxide	AA
R858	VRD-RM2HD332J	J	3.3k 1/2W Carbon	AA
R866	VRD-RM2HD332J	J	3.3k 1/2W Carbon	AA
R874	VRD-RM2HD332J	J	3.3k 1/2W Carbon	AA
R881	VRD-RA2BE102J	J	1.0k 1/8W Carbon	AA
R882	VRD-RA2BE331J	J	330 1/8W Carbon	AA
R883	VRD-RA2BE561J	J	560 1/8W Carbon	AA
R884	VRD-RA2BE152J	J	1.5k 1/8W Carbon	AA

**MISCELLANEOUS PARTS**

P851	QPLGN0541CEZZ	J	Plug	AB
P852	QPLGN0441CEZZ	J	Plug	AB
SC851	QSOCV0829CEZZ	J	Socket,CRT	AK

**MISCELLANEOUS PARTS**

⚠	QACCD3014CESA	J	AC Cord	AH
	QCNW-1495PEZZ	R	Connecting Cord	AE
	QCNW-1768PEZZ	R	Connecting Cord	AF
	QCNW-1769PEZZ	R	Connecting Cord	AG
⚠	RUNTK0393CEZZ	J	Antenna Adaptor	AH
	VSP0080P-H28A	J	Speaker	AM

**PACKING PARTS  
(NOT REPLACEMENT ITEM)**

SPAKC5957PEZZ	R	Packing Case	—
SPAKP0031PEZZ	R	Wrapping Paper	—
SPAKX2527PEZZ	R	Polystyrene Mat	—

Ref. No.	Part No.	*	Description	Code
<b>CABINET PARTS</b>				
1	CCABA2276WEV0	R	Cabinet Comrete Ass'yBA	
1-1	-	R	Cabinet Front	—
1-2	GCOVA0053PEKA	R	Cover,R/C	AE
1-3	JBTN-0167PEKA	R	Button,Power,VOL- up/down	AG
1-4	JBTN-0168PEKA	R	Button,CH-up/down	AF
2	GCABB2238PEKA	R	Rear Cabinet	AY

**SUPPLIED ACCESSORIES**

QANTR0018PEZZ	R	Rod Antenna	AQ
RRMCG1124CESA	J	Infrared R-C -BATTERY	AW -
TGAN-0018PEZZ	R	Guarantee Card	AD
TiNS-5536PEZZ	R	Operation Manual	
SSAKA0001PEZZ	R	Polystyrene Bag	AA

**CABINET PARTS LOCATION**

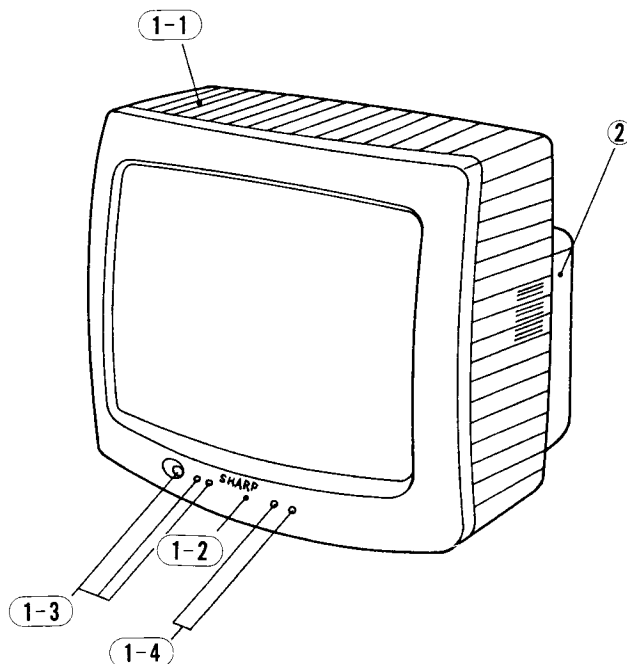

# PRINTED WIRING BOARD ASSEMBLIES

(All the PWB's here are shown as viewed from their wiring sides.)

H  
G  
F  
E  
D  
C  
B  
A

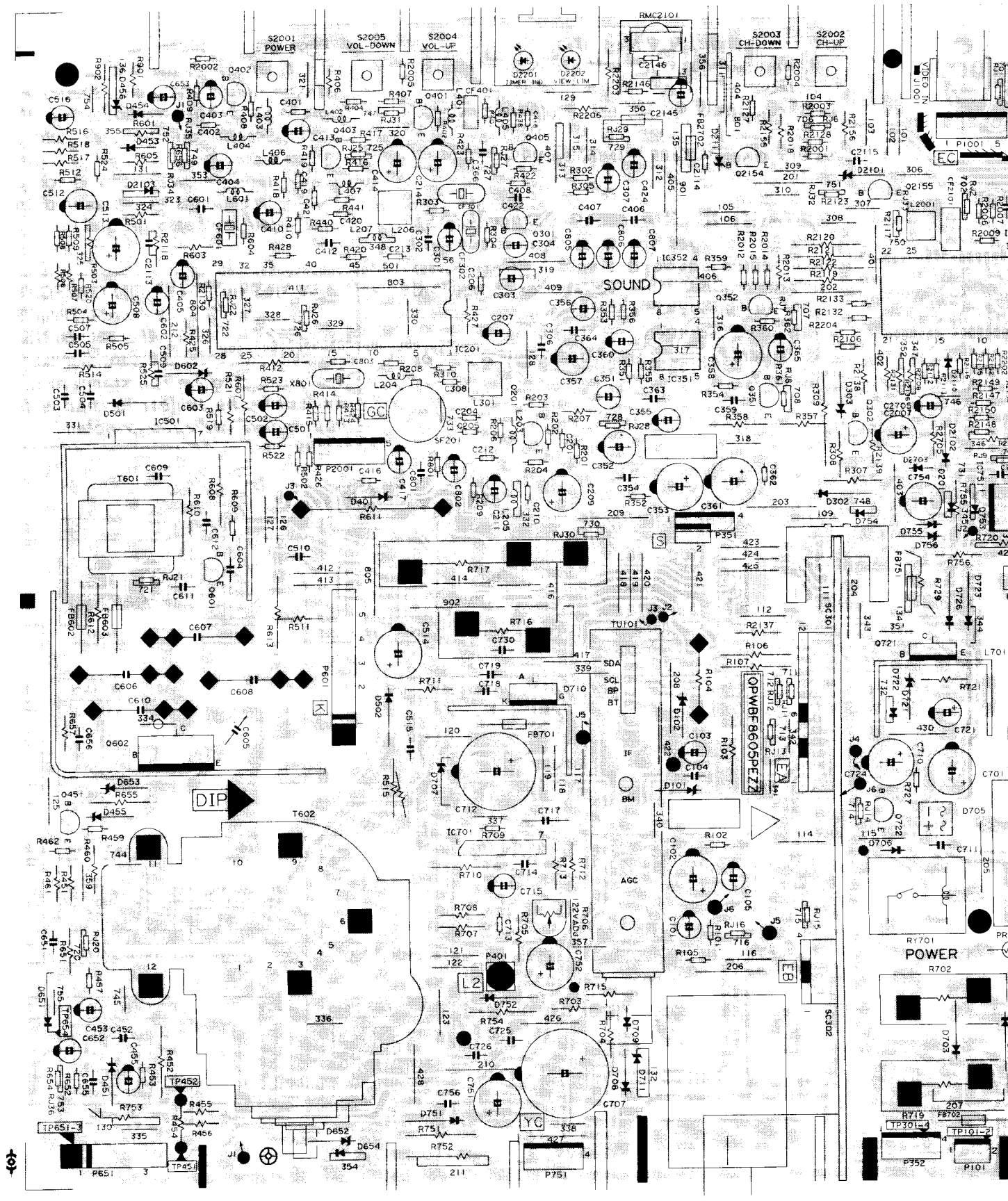

PWB-A

1 2 3 4 5 6 7

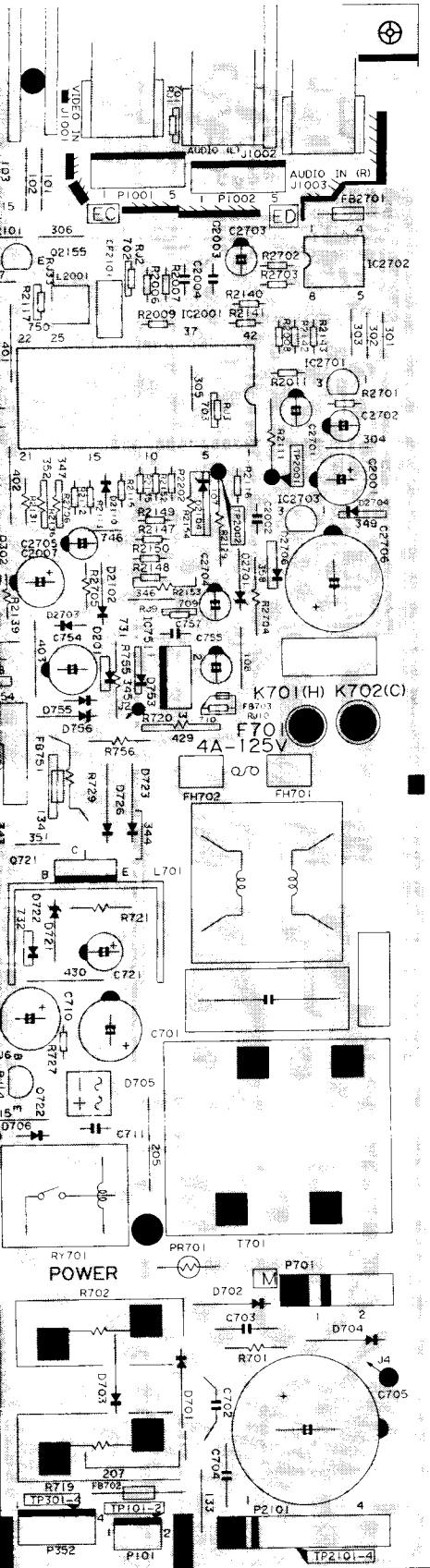

101

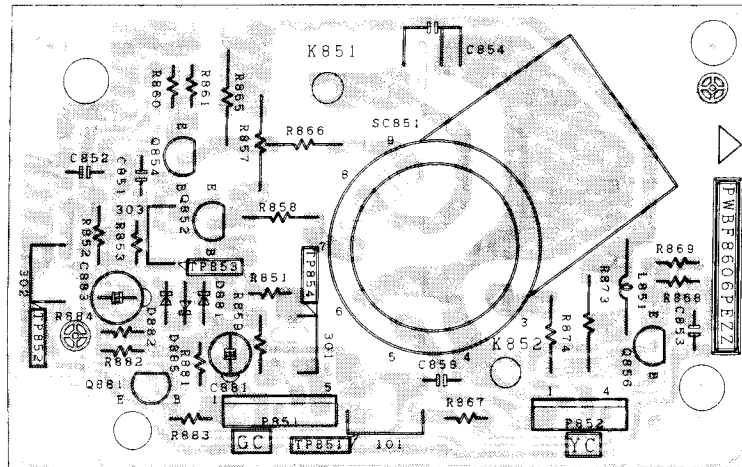

PWB-B

# SCHEMATIC DIAGRAM: MAIN

H  
G  
F  
E  
D  
C  
B  
A

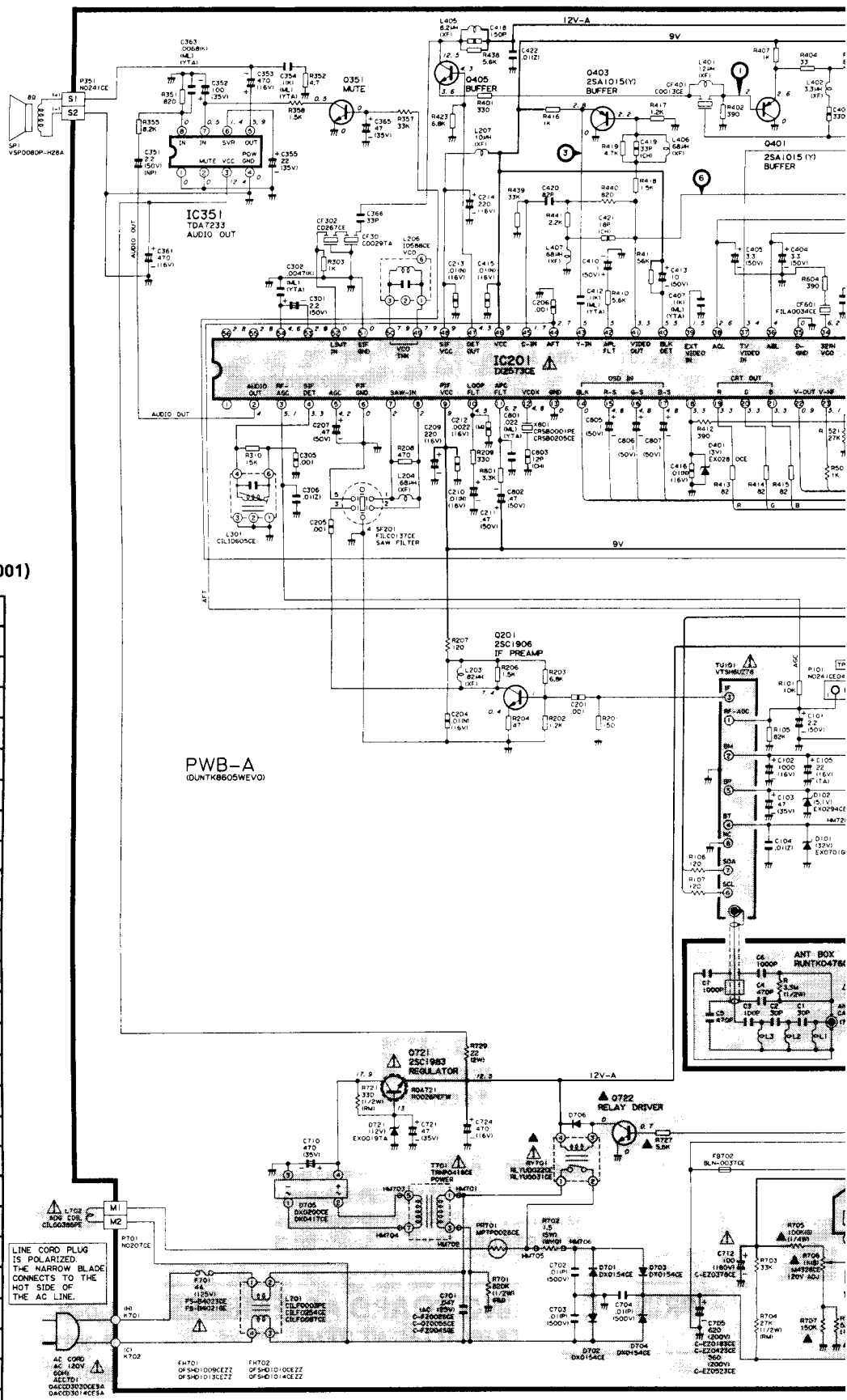

INDICATION OF SENSOR IC VOLTAGE (IC2001)

Pin No.	IC2001 Logic or Voltage Levels
3	H-Mute on L-Mute off
6	H-TV L-Video
8	H-Power on L-Power off
12	Station Detector (H-Pulse in)
13	Negative Pulse
14	AFT Voltage Input
16	X-RAY Protector
19	View Timer L-LED on
19	View Timer L-LED on
20	On time L-LED on
22	Pulse (Active High)
23	Pulse (Active High)
24	Pulse (Active High)
25	Pulse (Active High)
26	Negative Pulse(H-Sync)
27	Negative Pulse(V-Sync)
28	OSD 12.08MHz
29	OSD 12.08MHz
31	OSC Input (8MHz)
32	OSC Output (8MHz)
33	Reset (Active High)
36	Negative Pulse
37	Serial Clock
38	Serial Clock
40	Caption Control (Composite Video)
41	Caption Control (Composite Video)

1 2 3 4 5 6

NOTE: ALL DIODES ARE "1SS119" "DX0045GE" OR "DX0446CE" UNLESS OTHERWISE SPECIFIED.  
 ALL TRANSISTORS ARE "2SC945A(D)" OR "2SC1815(Y)" UNLESS OTHERWISE SPECIFIED.

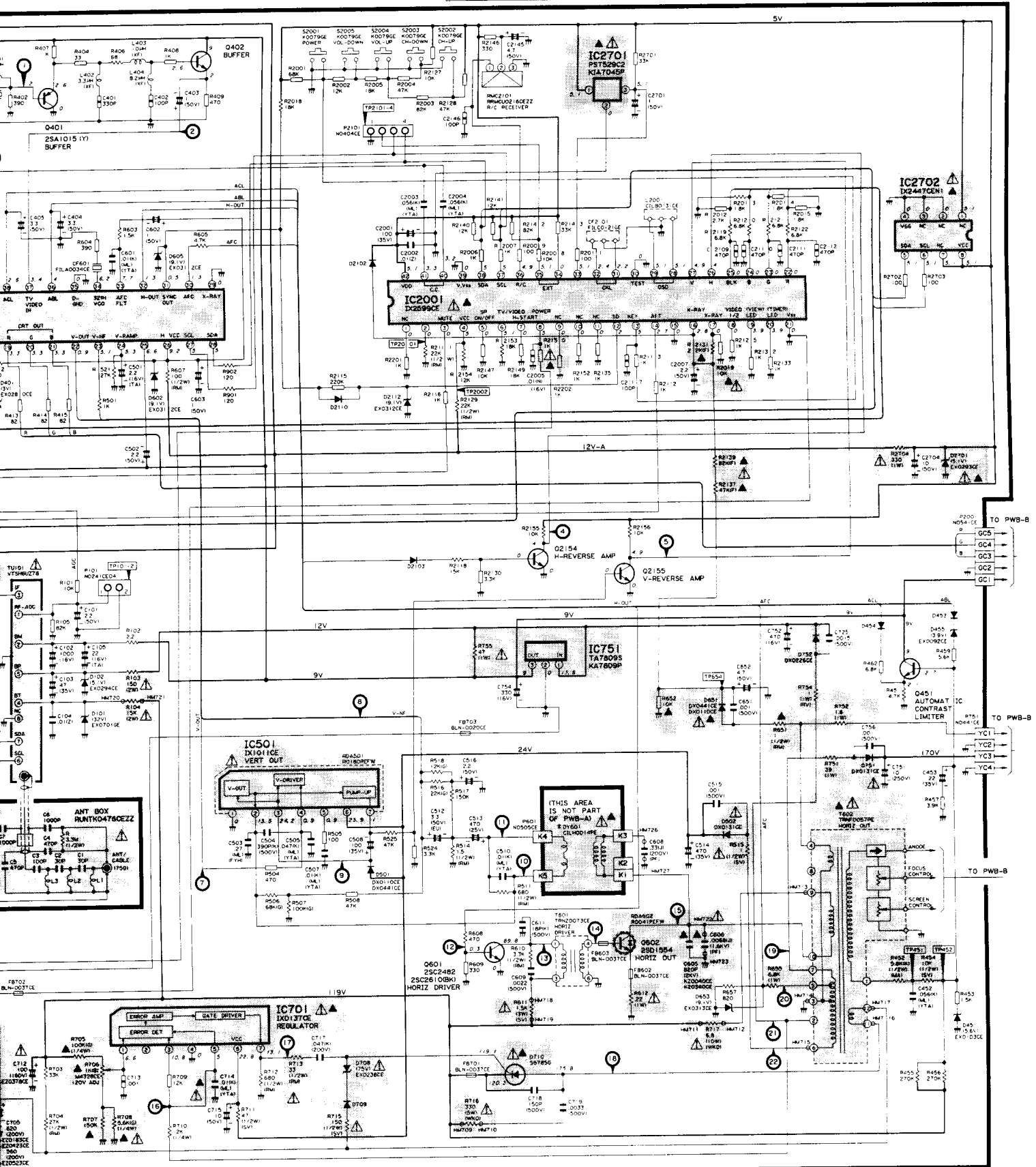

# DESCRIPTION OF SCHEMATIC DIAGRAM

## NOTE:

1. The unit of resistance "ohm" is omitted (K:1000 ohms, M:1 Meg ohm).
2. All resistors are 1/8 watt, unless otherwise noted.
3. All capacitors are  $\mu\text{F}$ , unless otherwise noted P:  $\mu\mu\text{F}$ .
4. (G) indicates  $\pm 2\%$  tolerance may be used.

## VOLTAGE MEASUREMENT CONDITIONS:

1. All DC voltages are measured with VTVM connected between points indicated and chassis ground, line voltage set at 120V AC and all controls set for normal picture unless otherwise indicated.
2. All voltages measured with 1000 $\mu\text{V}$  B & W or Color signal.

## WAVEFORM MEASUREMENT CONDITIONS:

1. Photographs taken on a standard gated color bar signal, the tint setting adjusted for proper color. The wave shapes at the red, green and blue cathodes of the picture tube depend on the tint, color level and picture control.
2.  indicates waveform check points (See chart, waveforms are measured from point indicated to chassis ground.)

 AND SHADED (  ) COMPONENTS = SAFETY RELATED PARTS.  
 MARK = X-RAY RELATED PARTS.

This circuit diagram is a standard one, printed circuits may be subject to change for product improvement without prior notice.

## WAVEFORMS

